



GRILLES

Avair Grille - Plastic	72
Bevel Face Diffuser - Metal	73
Classic Diffuser - Plastic	74
Door Relief Grille - Metal	75
Double Deflection Register - Fixed Core	76
Double Deflection Register - Removable Core	77
Egg Crate Grilles	78
Floor Boot - Metal	82
Floor Boot - Plastic	82
Floor Grille - Metal	82
Floor Grille - Plastic	83
Floor Register - Plastic	83
Jet Diffusers	84
Jet Ball Diffusers	84
Linear Bar Grille - Removable Core	85
Linear Slot Diffuser (LSD)	85
Louvre Face Diffuser (LFD)	86
MDO-S	87
MDO-X	88
Side Entry Box - Plastic	90
Opposed Blade Damper (OBD)	91
Outside Air Louvre	92
RAG-H Return Air Grille	93
RAG-X Return Air Grille	94
Round Ceiling Diffuser	96
Round Heritage Outlet	97
Round Outlet - Multi Cone Diffusers	97
Roundjet - Plastic	98
Security Relief Grille	99
Silent Air Grille	99
Square Swirl Diffusers - Model PSA	100
Square Swirl Diffusers - Model PSB	101
Square Swirl Diffusers - Model PSC	102

Avair Grille



The Polyaire Avair Ceiling Grille has been designed to provide a versatile and practical louvre grille. Designed with a purpose built integrated neck adaptor it can be manufactured to incorporate an air volume control balancing damper within the neck assembly.

A simple rotation of the grille centre engages the air volume damper allowing for adjustment of air flow from within the room.

Fixed spring loaded mounting clips allow for ease of installation, once the access hole is cut the unit is simply inserted and the clips engage automatically.

Manufactured from ABS material the Polyaire Avair Ceiling Grille will not corrode, fade or discolour and is highly suitable for domestic installations.

Avair Grille - Plastic

Sizes Available/Dimensions

Item #	Description	Nominal Neck Size		Face Size		Spigot Size	
		mm	inch	mm	inch	mm	inch
231001	Avair Grille	250 x 250	10" x 10"	360 x 360	14" x 14"	Ø 200 - Ø 250	8" - 10"
231002	Avair Wand	N/A	N/A	N/A	N/A	N/A	N/A

polyaire
AIRCONDITIONING PRODUCTS

MDO-S

Multi Directional Outlet



For complete control and comfort using unique adjustable air flow louvres, check out the Polyaire MDO-S Ceiling Diffuser.

You can find more information about this product on Page 87

Bevel Face Diffuser



The Polyaire range of Square Ceiling Diffusers are designed to provide excellent directional performance typically in a 4 way airflow pattern. Manufactured from extruded aluminium the diffuser offers a removable core as standard while also providing options for 1, 2 & 3 way airflow patterns.

Square Ceiling Diffusers Model LFD-BB incorporate a Bevel Face frame and are used in surface mount ceiling applications where minimum ceiling smudging is required. Standard finish is powder coat white while other finishes are available to suit the interior and architectural design requirements.

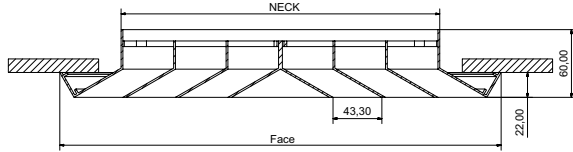

Bevel Faced Diffuser - Metal (Includes Adaptor)

Sizes Available/Dimensions

Item #	Description	Nominal Neck Size		Face Size		Spigot Size	
		mm	inch	mm	inch	mm	inch
247053	3 Way	225 x 225	9" x 9"	338 x 338	13" x 13"	Ø 200	Ø 8"
247054	4 Way	225 x 225	9" x 9"	338 x 338	13" x 13"	Ø 200	Ø 8"
247055	3 Way	300 x 300	12" x 12"	413 x 413	16" x 16"	Ø 200	Ø 8"
247056	4 Way	300 x 300	12" x 12"	413 x 413	16" x 16"	Ø 200	Ø 8"
247058	2 Way	300 x 300	12" x 12"	413 x 413	16" x 16"	Ø 250	Ø 10"
247059	2 Way	300 x 300	12" x 12"	413 x 413	16" x 16"	Ø 250	Ø 10"
247060	3 Way	300 x 300	12" x 12"	413 x 413	16" x 16"	Ø 250	Ø 10"
247061	4 Way	300 x 300	12" x 12"	413 x 413	16" x 16"	Ø 250	Ø 10"
247062	3 Way	300 x 300	12" x 12"	413 x 413	16" x 16"	Ø 300	Ø 12"
247063	4 Way	300 x 300	12" x 12"	413 x 413	16" x 16"	Ø 300	Ø 12"
245411	3 Way AD	375 x 375	15" x 15"	488 x 488	19" x 19"	Ø 150	Ø 6"
247064	3 Way	375 x 375	15" x 15"	488 x 488	19" x 19"	Ø 300	Ø 12"
247065	4 Way	375 x 375	15" x 15"	488 x 488	19" x 19"	Ø 300	Ø 12"
247077	4 Way	375 x 375	15" x 15"	488 x 488	19" x 19"		N/A

Bevel Faced Diffuser - Aluminium

Sizes Available/Dimensions

Item #	Description	Nominal Neck Size		Face Size	
		mm	inch	mm	inch
245434	4 Way	450 x 450	18" x 18"	563 x 563	22" x 22"

Bevel Faced Diffuser - Neck Adaptors

Sizes Available/Dimensions

Item #	Nominal Neck Size		Spigot Size	
	mm	inch	mm	inch
447078	450 x 450	18" x 18"	Ø 200	8"
447079	450 x 450	18" x 18"	Ø 250	10"
447080	450 x 450	18" x 18"	Ø 300	12"

Classic Diffuser



The Classic Diffuser from Polyaire has been designed to provide stylish elegance at an economical price.

The diffuser has been specially designed to give optimum four way airflow whilst complimenting almost any décor.

Features

- Classic modern design
- Attractive sculptured bevelled face
- Four way airflow
- High grade engineering plastic (ABS) construction
- Comprehensive range of neck adaptors
- Removable centre core for ease of cleaning
- Suitable for reverse cycle, gas & evaporative systems

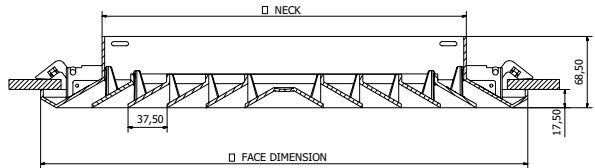

Classic Bevel Faced Diffuser - Plastic

Sizes Available/Dimensions

Item #	Description	Nominal Neck Size		Face Size	
		mm	inch	mm	inch
231319	4 Way	230 x 230	9" x 9"	328 x 328	13" x 13"
231324	4 Way	300 x 300	12" x 12"	403 x 403	16" x 16"
231329	4 Way	350 x 350	14" x 14"	468 x 468	18" x 18"

Classic Bevel Faced Diffuser - Plastic - Kits

Sizes Available/Dimensions

Item #	Nominal Neck Size		Spigot Size	
	mm	inch	mm	inch
231230	230 x 230	9" x 9"	Ø 150	6"
231231	230 x 230	9" x 9"	Ø 200	8"
231232	300 x 300	12" x 12"	Ø 200	8"
231233	300 x 300	12" x 12"	Ø 250	10"
231234	300 x 300	12" x 12"	Ø 300	12"
231235	350 x 350	14" x 14"	Ø 300	12"
231236	350 x 350	14" x 14"	Ø 350	14"

Door Relief Grille

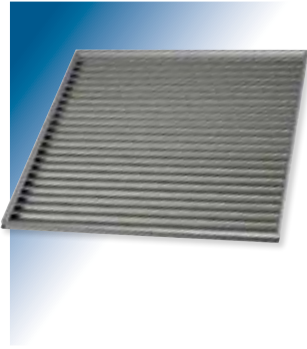

Polyaire Model DG-FC Door Relief Grilles are designed for use in doors where constant air transfer is required along with non-vision (sight proof).

Construction is from all aluminium extrusion with fixed full chevron blades.

Standard finish is natural anodised while other finishes including powder coat are available to suit the interior and architectural design requirements.

Model DG-FC Louvre Grilles are available in stock sizes and can also be manufactured to order in a wide range of sizes.

Free area is 50%

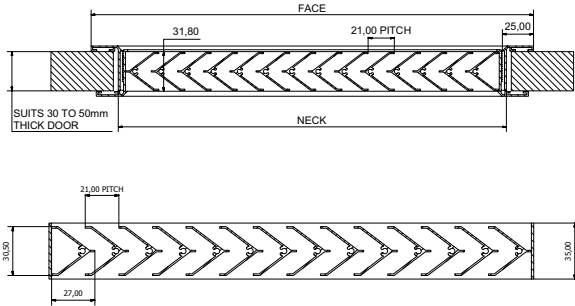

Door Relief Grille - Metal

Sizes Available/Dimensions

Item #	Nominal Neck Size		Face Size	
	mm	inch	mm	inch
244236	300 x 300	12" x 12"	330 x 330	13" x 13"
244237	450 x 150	18" x 6"	480 x 180	19" x 7"
244625	450 x 200	18" x 8"	480 x 230	19" x 9"
244627	450 x 300	18" x 12"	480 x 330	19" x 13"
244021	600 x 150	24" x 6"	630 x 180	25" x 7"
244022	600 x 200	24" x 8"	630 x 230	25" x 9"
244023	600 x 250	24" x 10"	630 x 280	25" x 11"
244024	600 x 300	24" x 12"	630 x 330	25" x 13"
244238	600 x 350	24" x 14"	630 x 380	25" x 15"
244026	600 x 400	24" x 16"	630 x 430	25" x 17"
244239	600 x 450	24" x 18"	630 x 480	25" x 19"
244028	600 x 600	24" x 24"	630 x 630	25" x 25"

Double Deflection Register - Fixed Core



Features

- Universal Outlets or Double Deflection Registers are generally used in sidewall applications.
- Consist of two separate rows of individually adjustable vanes - Front and Rear Vanes.
- Front Vanes - horizontal so the primary air leaving the outlet is directed above the room occupants and does not reach the occupied zone until well mixed with the secondary room air.
- Rear Vanes - vertical and are used to direct the air in a straight blow or spread the air as required by the room layout. If required, air flow can be directed at an angle to one or both sides, and still retain a near-parallel air stream pattern.
- Construction is all extruded aluminium horizontal and vertical blades, retained in a fixed or removable Core.
- Standard finish is powder coat white while other finishes are available to suit the interior and architectural design requirements.

Double Deflection Register - Metal - Fixed Core

Item #	Sizes Available/Dimensions			
	Nominal Neck Size		Face Size	
	mm	inch	mm	inch
244611	300 x 100	12" x 4"	339 x 139	13" x 5"
245528	300 x 150	12" x 6"	339 x 189	13" x 7"
244619	300 x 200	12" x 8"	339 x 239	13" x 9"
244613	350 x 150	14" x 6"	389 x 189	15" x 7"
244614	400 x 150	16" x 6"	439 x 189	17" x 7"
244615	400 x 200	16" x 8"	439 x 239	17" x 9"
245667	400 x 250	16" x 10"	439 x 289	17" x 11"
245668	500 x 150	20" x 6"	539 x 189	21" x 7"
245669	500 x 200	20" x 8"	539 x 239	21" x 9"
244618	500 x 250	20" x 10"	539 x 289	21" x 11"
245670	500 x 300	20" x 12"	539 x 339	21" x 13"
245671	600 x 150	24" x 6"	639 x 189	25" x 7"
244616	600 x 200	24" x 8"	639 x 239	25" x 9"
245672	600 x 250	24" x 10"	639 x 289	25" x 11"
245673	600 x 400	24" x 16"	639 x 439	25" x 17"

Double Deflection Register - Removable Core



Double Deflection Register - Metal - Removable Core

Item #	Nominal Neck Size		Face Size	
	mm	inch	mm	inch
247300	300 x 100	12" x 4"	353 x 153	14" x 6"
247301	300 x 150	12" x 6"	353 x 203	14" x 8"
244217	300 x 200	12" x 8"	353 x 253	14" x 10"
244218	300 x 250	12" x 10"	353 x 303	14" x 12"
244049	300 x 300	12" x 12"	353 x 353	14" x 14"
244501	350 x 100	14" x 4"	403 x 153	16" x 6"
247302	350 x 150	14" x 6"	403 x 203	16" x 8"
244085	350 x 200	14" x 8"	403 x 253	16" x 10"
244391	350 x 250	14" x 10"	403 x 303	16" x 12"
245107	350 x 300	14" x 12"	403 x 353	16" x 14"
244086	350 x 350	14" x 14"	403 x 403	16" x 16"
244150	400 x 100	16" x 4"	453 x 153	18" x 6"
247303	400 x 150	16" x 6"	453 x 203	18" x 8"
247304	400 x 200	16" x 8"	453 x 253	18" x 10"
244087	400 x 250	16" x 10"	453 x 303	18" x 12"
244220	400 x 300	16" x 12"	453 x 353	18" x 14"
244088	400 x 400	16" x 16"	453 x 453	18" x 18"
244089	450 x 150	18" x 6"	503 x 203	20" x 8"
247305	450 x 175	18" x 7"	503 x 228	20" x 9"
244051	450 x 200	18" x 8"	503 x 253	20" x 10"
244091	450 x 300	18" x 12"	503 x 353	20" x 14"
244227	450 x 450	18" x 18"	503 x 503	20" x 20"
244402	500 x 100	20" x 4"	553 x 153	22" x 6"
244221	500 x 150	20" x 6"	553 x 203	22" x 8"
244222	500 x 200	20" x 8"	553 x 253	22" x 10"
244223	500 x 250	20" x 10"	553 x 303	22" x 12"
244093	500 x 300	20" x 12"	553 x 353	22" x 14"
244608	500 x 400	20" x 16"	553 x 453	22" x 18"
244052	500 x 500	20" x 20"	553 x 553	22" x 22"
245129	600 x 100	24" x 4"	653 x 153	26" x 6"
244228	600 x 150	24" x 6"	653 x 203	26" x 8"
247306	600 x 175	24" x 7"	653 x 228	26" x 9"
244229	600 x 200	24" x 8"	653 x 253	26" x 10"
244230	600 x 250	24" x 10"	653 x 303	26" x 12"
244152	600 x 300	24" x 12"	653 x 353	26" x 14"
244606	750 x 250	30" x 10"	803 x 303	32" x 12"
245682	800 x 100	32" x 4"	853 x 153	34" x 6"

Egg Crate Grilles

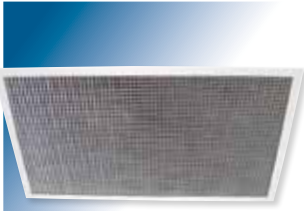

Polyaire Model EC Eggcrate Grilles are normally used in ceiling return air and exhaust applications.

Construction: The frame is made from an aluminium extrusion, which supports and retains the aluminium square pattern lattice core.

The standard frame flange is 25mm.

Standard finish is powder coat white while other finishes are available to suit the interior and architectural design requirements.

Model EC-FC, EC-LC, EC-RC and EC-HF are available in stock sizes and can also be manufactured to order in a wide range of sizes.

See page 156 for TBars

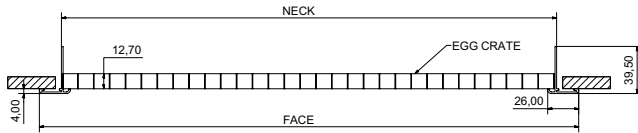

Eggcrate Grille - Metal - Fixed Core

Sizes Available/Dimensions

Item #	Nominal Neck Size		Face Size	
	mm	inch	mm	inch
245593	150 x 150	6" x 6"	195 x 195	8" x 8"
245595	200 x 200	8" x 8"	245 x 245	10" x 10"
245596	250 x 250	10" x 10"	295 x 295	12" x 12"
245597	300 x 300	12" x 12"	345 x 345	14" x 14"
245599	350 x 350	14" x 14"	395 x 395	16" x 16"
245603	400 x 400	16" x 16"	445 x 445	18" x 18"
245604	450 x 450	18" x 18"	495 x 495	20" x 20"
245605	500 x 500	20" x 20"	545 x 545	22" x 22"
245625	550 x 250	22" x 10"	595 x 295	23" x 12"
245610	550 x 550	22" x 22"	595 x 595	23" x 23"
245619	1150 x 550	45" x 22"	1195 x 595	47" x 23"

Eggcrate Grille - Metal - Fixed Core Neck Adaptors (C/W Butterfly Blades & Fixing Clips)

Sizes Available/Dimensions

Item #	Neck Size		Spigot Size	
	mm	inch	mm	inch
247221	150 x 150	6" x 6"	Ø 150	Ø 6"
247222	200 x 200	8" x 8"	Ø 150	Ø 6"
247223	200 x 200	8" x 8"	Ø 200	Ø 8"
247224	250 x 250	10" x 10"	Ø 200	Ø 8"
247225	300 x 300	12" x 12"	Ø 250	Ø 10"

Egg Crate Grilles

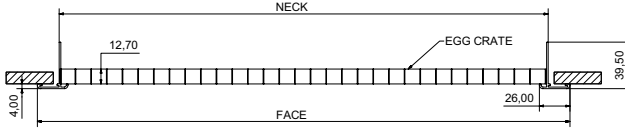

Eggcrate Grille - Metal - Loose Core

Sizes Available/Dimensions

Item #	Nominal Neck Size		Face Size	
	mm	inch	mm	inch
244029	150 x 150	6" x 6"	182 x 182	8" x 8"
244030	200 x 200	8" x 8"	232 x 232	10" x 10"
244031	250 x 250	10" x 10"	282 x 282	12" x 12"
244032	300 x 300	12" x 12"	332 x 332	14" x 14"
244033	350 x 350	14" x 14"	382 x 382	16" x 16"
244038	400 x 400	16" x 16"	432 x 432	18" x 18"
244034	450 x 450	18" x 18"	482 x 482	20" x 20"
244572	500 x 500	20" x 20"	532 x 532	22" x 22"
244037	563 x 263	22" x 10"	595 x 295	23" x 12"
244035	563 x 563	22" x 22"	595 x 595	23" x 23"
245188	600 x 300	24" x 12"	632 x 332	25" x 14"
244482	600 x 400	24" x 16"	632 x 432	25" x 18"
244592	600 x 450	24" x 18"	632 x 482	25" x 20"
244591	900 x 500	35" x 20"	932 x 532	37" x 22"
244036	1163 x 563	46" x 22"	1195 x 595	47" x 23"

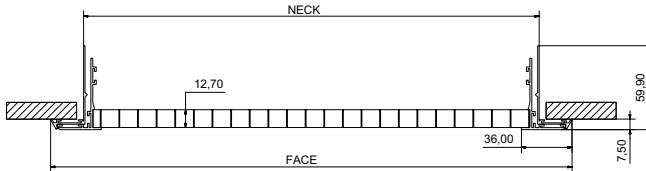

Eggcrate Grille - Metal - Removable Core

Sizes Available/Dimensions

Item #	Nominal Neck Size		Face Size	
	mm	inch	mm	inch
244288	150 x 150	6" x 6"	195 x 195	8" x 8"
244289	200 x 200	8" x 8"	245 x 245	10" x 10"
244290	250 x 250	10" x 10"	295 x 295	12" x 12"
244291	300 x 300	12" x 12"	345 x 345	14" x 14"
244292	350 x 350	14" x 14"	395 x 395	16" x 16"
244293	400 x 400	16" x 16"	445 x 445	18" x 18"
244294	450 x 450	18" x 18"	495 x 495	20" x 20"
244301	550 x 250	22" x 10"	595 x 295	23" x 12"
244305	550 x 550	22" x 22"	595 x 595	23" x 23"
244306	1150 x 550	45" x 22"	1195 x 595	47" x 23"

Egg Crate Grilles



The Polyaire Model EC-HF Return Air Egg Crate Grille & Filter (Metal) is the one product which offers complete and simple service ability for all situations.

A unique design which can easily be installed and offer the latest in disposable filter pad technology. Ideally suited to environments where regular maintenance of the filter media is a concern, the Return Air Egg Crate Grille & Filter is designed for quick, simple filter pad change.

The actual filter pad is a product of exhaustive research by one of the world's largest air filtration authorities with approval from the American Underwriters Laboratories. A distinct black coloured filter media shows dirt and particle build up and provides for ready inspection prior to replacement as required.

Filters are available upon request.

See page 156 for TBars

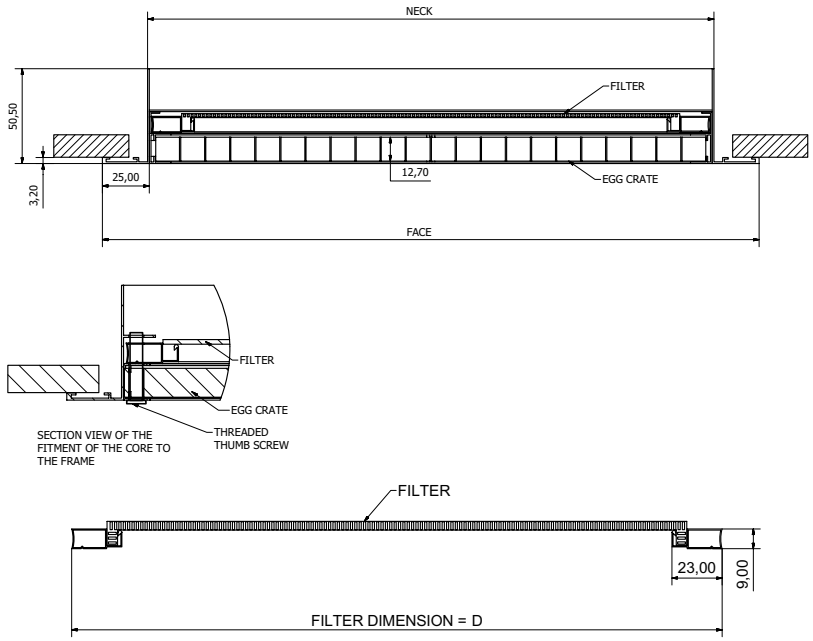

Egg Crate Grilles

Eggcrate Grille - Metal - Hinged Filter (Polyester)

Item #	Sizes Available/Dimensions			
	Nominal Neck Size		Face Size	
	mm	inch	mm	inch
245225	300 x 300	12" x 12"	347 x 347	14" x 14"
244132	400 x 400	16" x 16"	447 x 447	18" x 18"
244135	500 x 400	20" x 16"	547 x 447	22" x 18"
244398	500 x 500	20" x 20"	547 x 547	22" x 22"
247207	550 x 550	22" x 22"	595 x 595	23" x 23"
244040	600 x 300	26" x 12"	647 x 347	25" x 14"
247200	600 x 400	24" x 16"	647 x 447	25" x 18"
244042	600 x 450	26" x 18"	647 x 497	25" x 20"
244137	600 x 500	26" x 20"	647 x 547	25" x 22"
245230	600 x 550	26" x 22"	647 x 597	25" x 24"
245232	600 x 600	26" x 26"	647 x 647	25" x 25"
245231	650 x 550	26" x 22"	697 x 597	27" x 24"
245378	700 x 400	28" x 16"	747 x 447	29" x 18"
244311	700 x 500	28" x 20"	747 x 547	29" x 22"
245675	700 x 550	28" x 22"	747 x 597	29" x 24"
245678	700 x 700	28" x 28"	747 x 747	29" x 29"
247201	750 x 400	30" x 16"	797 x 447	31" x 18"
247202	750 x 450	30" x 18"	797 x 497	31" x 20"
245234	750 x 500	30" x 20"	797 x 547	31" x 22"
247203	750 x 550	30" x 22"	797 x 597	31" x 24"
244312	800 x 300	32" x 12"	847 x 347	33" x 14"
244313	800 x 350	32" x 14"	847 x 397	33" x 16"
245621	800 x 500	32" x 20"	847 x 547	33" x 22"
245623	800 x 600	32" x 26"	847 x 647	33" x 25"
245674	800 x 700	32" x 28"	847 x 747	33" x 29"
244645	850 x 600	34" x 26"	897 x 647	35" x 25"
247204	900 x 400	35" x 16"	947 x 447	37" x 18"
244045	900 x 450	35" x 18"	947 x 497	37" x 20"
247206	900 x 500	35" x 20"	947 x 547	37" x 22"
247205	900 x 550	35" x 22"	947 x 597	37" x 24"
244109	900 x 600	35" x 26"	947 x 647	37" x 25"
245437	1000 x 400	39" x 16"	1047 x 447	41" x 18"
245426	1100 x 500	43" x 20"	1147 x 547	45" x 22"
247208	1150 x 550	45" x 45"	1195 x 595	47" x 24"
245379	1200 x 400	47" x 16"	1247 x 447	49" x 18"

Floor Boot - Metal



Side Entry Boot

Manufactured from galvanised steel and come in a wide range of sizes and outlet configurations.

Floor Boot - Metal

Sizes Available/Dimensions

Item #	Description	Nominal Neck Size		Spigot Size	
		mm	inch	mm	inch
442304	Side Boot	350 x 150	14" x 6"	Ø 250	Ø 10"
442310	Uni Boot	350 x 150	14" x 6"	Ø 250	Ø 10"

Floor Boot - Plastic



Angle Boot

Features

- The specifically designed floor boot with manual balancing air flow damper and off set entry spigot allows for easy installation in confined areas.
- The air flow damper incorporated in the grille face permits the 'shut off' of outlets as required for total air control.
- Non corrosive
- High impact ABS material
- Shut off damper
- Integrated boot
- Many popular colours
- Suitable for high corrosive areas

Floor Boot - Plastic

Sizes Available/Dimensions

Item #	Description	Nominal Neck Size		Spigot Size	
		mm	inch	mm	inch
431072	Angled	300 x 100	12" x 4"	Ø 150	Ø 6"
434520	Straight	300 x 100	12" x 4"	Ø 150	Ø 6"
434071	Straight	300 x 100	12" x 4"	Ø 200	Ø 8"
434175	Angled	300 x 100	12" x 4"	Ø 200	Ø 8"
434489	Angled	300 x 150	12" x 6"	Ø 200	Ø 8"
434490	Angled	300 x 150	12" x 6"	Ø 250	Ø 10"

Floor Grille - Metal



Features

- Available in two sizes -350 x 150 (large) suitable for air conditioning systems or a dual gas / cooling system and 300 x 100 used mainly for gas ducting heating only due to lower airflow delivery.
- Available in many colours.

Floor Grille - Metal

Sizes Available/Dimensions

Item #	Nominal Neck Size	
	mm	inch
244119	300 x 100	12" x 4"
244118	350 x 150	14" x 6"
244120	400 x 100	16" x 4"

Floor Grille - Plastic



Features

- Designed to effectively maximise the airflow performance of each individual outlet.
- The 'cross floor' pattern allows conditioned air to be discharged at exactly the right angle to maintain room comfort.
- Manufactured from high impact Polycarbonate which is extremely tough and ideally suited to heavy traffic areas.
- Available in many colours to complement all decor.

Floor Grille - Plastic

Sizes Available/Dimensions

Item #	Description	Nominal Neck Size	
		mm	inch
231101	Beige	300 x 100	12" x 4"
231105	Baltic Pine	300 x 100	12" x 4"
231100	Chocolate	300 x 100	12" x 4"
231107	Cream	300 x 100	12" x 4"
231103	Light Grey	300 x 100	12" x 4"
231104	Slate	300 x 100	12" x 4"
231073	White	300 x 100	12" x 4"

Floor Register



Features

- Features an updated closing mechanism with new twin dampers for efficient air flow control which allows accurate control of airflow and is easier to open and shut.
- Easy to keep clean - does not collect dirt easily.
- The twin blade design has the added benefit of deflecting air forward when the blades are set at 45 degrees which minimises the need for separate air deflectors.
- Made from material which is tough and can withstand household wear and tear. Will not rust, chip, bend or fade.
- Available in two sizes and various colours to suit all decor.

Floor Register - Plastic

Sizes Available/Dimensions

Item #	Description	Nominal Neck Size	
		mm	inch
234577	Beige	350 x 150	14" x 6"
234578	Chocolate	350 x 150	14" x 6"
234579	Mushroom	350 x 150	14" x 6"
234580	Grey	350 x 150	14" x 6"
234581	Slate	350 x 150	14" x 6"
234582	Baltic Pine	350 x 150	14" x 6"
234583	Cream	350 x 150	14" x 6"
234584	White	350 x 150	14" x 6"

Jet Diffusers



The Polyaire JAD Jet Diffuser is designed for the supply of large air volumes where long throw distances are required.

Polyaire Jet Diffusers are used extensively in large areas and high ceiling applications such as Sports Centres, Airports, Entertainment Complexes, Shopping Centres and Industrial areas.

Jet Diffusers are also used for Spot Cooling or Heating and the Jet diffuser can be rotated by 180 degree by adjusting the core, changing the throw pattern from Jet to Diffused Mode.

The Polyaire Jet Diffuser is available as a single unit or alternatively multiple units can be mounted in a panel. Construction is from spun aluminium.

Standard finish is powder coat white while other finishes are available to suit the interior and architectural design requirements.

Jet Diffuser - Metal

Sizes Available/Dimensions

Item #	Nominal Neck Size		Face Size	
	mm	inch	mm	inch
245291	Ø 200	8"	Ø 250	10"
245292	Ø 250	10"	Ø 300	12"
245293	Ø 300	12"	Ø 350	14"
245294	Ø 350	14"	Ø 400	16"
245295	Ø 400	16"	Ø 450	18"

Jet Ball Diffusers



Jet Ball Diffusers

Description

Model	Description
245320	Jet Ball Diffuser 200
245321	Jet Ball Diffuser 250
245322	Jet Ball Diffuser 350
245323	Jet Ball Diffuser 315
245324	Jet Ball Diffuser 400

Linear Bar Grille - Removable Core



Linear Bar Grille - Metal - Removable Core

Sizes Available/Dimensions					
Item #	Nominal Neck Size		Face Size		
	mm	inch	mm	inch	
247307	400 x 100	16" x 4"	440 x 140	17" x 6"	
247308	600 x 100	24" x 4"	640 x 140	25" x 6"	
247309	800 x 100	32" x 4"	840 x 140	33" x 6"	
247310	350 x 100	14" x 4"	390 x 140	15" x 6"	
247311	400 x 150	16" x 6"	440 x 190	17" x 8"	
247312	800 x 150	32" x 6"	840 x 190	33" x 8"	

Linear Slot Diffuser (LSD)



The Polyaire Linear Slot Diffusers are an attractive alternative to the ceiling or high sidewall supply diffusers.

Slot diffusers can be installed individually in set lengths or in a continuous line. They can also be installed in any type of ceiling application.

The modules are available with a 20mm or 25mm Slot with the number of slots ranging from 1 to 8 slots and are further available as fixed or removable core. (Fixed Core - Model LSD-FC, Removable Core - LSD-RC.

The air pattern control is adjustable from the diffuser face and is achieved by means of an adjustable pattern control with each slot, enabling a full 180° air pattern adjustment. The suggested volume control should be from the main duct run take-off, or from a butterfly damper fitted to the inlet of the cushion head box.

Construction is from extruded aluminium and the recommended maximum length for each section is 3 metres. Standard finish is powder coat white while other finishes are available to suit the interior and architectural design requirements.

Linear Slot Diffuser - Metal - Fixed Core

Sizes Available/Dimensions							
Item #	Slot	Slot Width		Nominal Neck Size		Face Size	
		mm	inch	mm	inch	mm	inch
245297	1	20mm		1200 x 35	47" x 1"	1242 x 86	49" x 3"
245298	2	20mm		1200 x 69	47" x 3"	1242 x 124	49" x 5"
245310	3	20mm		600 x 102	24" x 4"	642 x 162	25" x 6"
245299	3	20mm		1200 x 102	47" x 4"	1242 x 162	49" x 6"

Linear Slot Diffuser - Metal - Loose Core & Removable Core

Sizes Available/Dimensions							
Item #	Slot	Slot Width		Nominal Neck Size		Face Size	
		mm	inch	mm	inch	mm	inch
245304	2	20mm		547 x 81	22" x 3"	595 x 145	23" x 6"
245306	2	20mm		598 x 105	23" x 4"	643 x 155	25" x 6"
245307	2	20mm		890 x 81	35" x 3"	938 x 145	37" x 6"
245308	2	20mm		990 x 81	39" x 3"	1038 x 145	41" x 6"
245305	2	20mm		1147 x 105	45" x 4"	1195 x 155	47" x 6"
245309	2	20mm		1190 x 81	47" x 3"	1238 x 145	49" x 6"
245311	3	20mm		1147 x 114	45" x 5"	1195 x 185	47" x 7"

Louvre Face Diffuser (LFD)

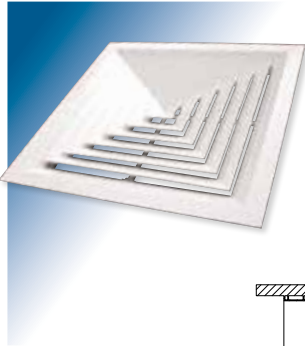

The Polyaire range of Square Ceiling Diffusers are designed to provide excellent directional performance typically in a 4 way airflow pattern.

Manufactured from extruded aluminium the diffuser offers a removable core as standard while also providing options for 1, 2 & 3 way airflow patterns.

The flush frame is designed for surface mounting in the ceiling or alternatively as a lay-in frame for T-Bar ceiling installations.

Standard finish is powder coat white while other finishes are available to suit the interior and architectural design requirements.

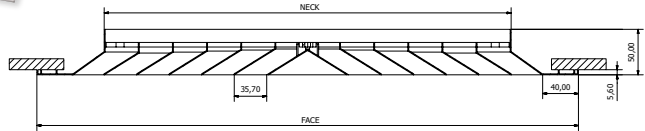

Louvre Face Diffuser - Metal

Sizes Available/Dimensions

Item #	Description	Nominal Neck Size		Face Size	
		mm	inch	mm	inch
247084	4 Way	150 x 150	6" x 6"	300 x 300	12" x 12"
247085	4 Way	225 x 225	9" x 9"	375 x 375	15" x 15"
247086	4 Way	300 x 300	12" x 12"	450 x 450	18" x 18"
247087	4 Way	375 x 375	15" x 15"	525 x 525	21" x 21"
247081	4 Way	450 x 450	18" x 18"	595 x 595	24" x 24"
247044	1 Way	450 x 450	18" x 18"	595 x 595	24" x 24"
247045	2 Way Cnr	450 x 450	18" x 18"	595 x 595	24" x 24"
247046	2 Way Opp	450 x 450	18" x 18"	595 x 595	24" x 24"
247080	3 Way	450 x 450	18" x 18"	595 x 595	24" x 24"

See page 156 for TBars

Louvre Face Diffuser - Metal - Kits

Sizes Available/Dimensions

Item #	Description	Nominal Neck Size		Face Size		Spigot Size	
		mm	inch	mm	inch	mm	inch
248000	4 Way	450 x 450	18" x 18"	595 x 595	24" x 24"	150 x 150	6" x 6"
248001	4 Way	450 x 450	18" x 18"	595 x 595	24" x 24"	225 x 225	9" x 9"
248002	4 Way	450 x 450	18" x 18"	595 x 595	24" x 24"	300 x 300	12" x 12"
248003	4 Way	450 x 450	18" x 18"	595 x 595	24" x 24"	375 x 375	15" x 15"

Kits includes Grilles & Neck Adaptors

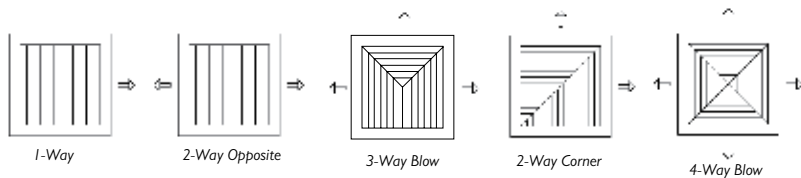

MDO-S



The new Polyaire Multi Directional Outlet - Square (MDO-S) is a ceiling diffuser that can direct air flow for complete control and comfort using unique adjustable air flow grilles.

Manufactured from high impact engineering grade plastic that adheres to internationally recognised standards, this grille will not chip, fade, corrode or discolour.

Features

- Made from tough engineering grade plastic.
- Comes in four sizes - 230, 300, 350 and 400.
- Shares the same biscuits as the current MDO-X.
- The same face and neck sizes as the current MDO-X.
- Square corners on the face.
- The same etching pattern on the face as the current MDO-X.
- Four spring loaded clips with locking mechanism at the corners.
- Delivers air flow with directional control adjustment from the room.
- Low resistance to airflow (correct installation).
- Fits various ceiling types and thickness.
- Suitable for all wet areas.
- Easy to clean.
- Will not corrode and is suitable for high salt content areas.
- A softer, more contemporary appearance with wider flanges, fillet corners and edges.
- Snap-In feature holds the biscuit firmly - less likelihood of dislodging when adjusting or cleaning.

MDO-S - Plastic

Sizes Available/Dimensions

Item #	Description	Nominal Neck Size		Face Size	
		mm	inch	mm	inch
231800	4 Way	230 x 230	9" x 9"	283 x 283	11" x 11"
231801	4 Way	300 x 300	12" x 12"	353 x 353	14" x 14"
231802	4 Way	350 x 350	14" x 14"	408 x 408	16" x 16"
231803	4 Way	400 x 400	16" x 16"	456 x 456	18" x 18"

See page 89 for Neck Adaptors. See page 90 for Side Entry Boxes.

MDO-S - Plastic - Kits (Available with or without damper)

Sizes Available/Dimensions

Item #	Nominal Neck Size		Spigot Size	
	mm	inch	mm	inch
231812	230 x 230	9" x 9"	Ø 150	Ø 6"
231813	230 x 230	9" x 9"	Ø 200	Ø 8"
231814	300 x 300	12" x 12"	Ø 200	Ø 8"
231815	300 x 300	12" x 12"	Ø 250	Ø 10"
231816	300 x 300	12" x 12"	Ø 300	Ø 12"
231817	350 x 350	14" x 14"	Ø 300	Ø 12"
231818	350 x 350	14" x 14"	Ø 350	Ø 14"
231825	350 x 350	14" x 14"	Ø 400	Ø 16"
231821	400 x 400	16" x 16"	Ø 350	Ø 14"
231822	400 x 400	16" x 16"	Ø 400	Ø 16"

MDO-X



The latest addition to the comprehensive range of Polyaire ceiling vents is the Adjustable Multi Directional Outlet (MDO-X). It's unique design means it can be both fixed and adjustable.

Features

- Completely flush louvre blades even when fully open, gives a smooth ceiling profile.
- Ideal for use in all fixed/adjustable applications as the increased holding force maintains the louvres in the desired position even in strong air flow.
- The finish is etched to reduce reflection and accept painting with no preparation, a major cost saving.
- Softer more contemporary appearance with wider flanges, fillet corners and edges.
- Snap-In feature holds the biscuit firmly
 - Less likelihood of dislodging when adjusting or cleaning.

MDO-X - Plastic

Sizes Available/Dimensions					
Item #	Description	Nominal Neck Size		Face Size	
		mm	inch	mm	inch
231200	4 Way	230 x 230	9" x 9"	283 x 283	11" x 11"
231201	4 Way	300 x 300	12" x 12"	353 x 353	14" x 14"
231202	4 Way	350 x 350	14" x 14"	408 x 408	16" x 16"
231203	4 Way	400 x 400	16" x 16"	456 x 456	18" x 18"
231204	4 Way	450 x 450	18" x 18"	506 x 506	20" x 20"
231205	6 Way	350 x 525	14" x 21"	406 x 581	16" x 23"

See page 89 for Neck Adaptors. See page 90 for Side Entry Boxes.

Accessories

Sizes Available/Dimensions	
Item #	Description
231054	Mounting Clips - New (4)
231064	MDO-X Plastic Mounting Clips

MDO-X - Plastic - Kits No Damper Metal Clips

Sizes Available/Dimensions					
Item #	Nominal Neck Size		Spigot Size		
	mm	inch	mm	inch	
231212	230 x 230	9" x 9"	Ø 150	Ø 6"	
231213	230 x 230	9" x 9"	Ø 200	Ø 8"	
231214	300 x 300	12" x 12"	Ø 200	Ø 8"	
231215	300 x 300	12" x 12"	Ø 250	Ø 10"	
231216	300 x 300	12" x 12"	Ø 300	Ø 12"	
231217	350 x 350	14" x 14"	Ø 300	Ø 12"	
231218	350 x 350	14" x 14"	Ø 350	Ø 14"	
231225	350 x 350	14" x 14"	Ø 400	Ø 16"	
231221	400 x 400	16" x 16"	Ø 350	Ø 14"	
231222	400 x 400	16" x 16"	Ø 400	Ø 16"	
231223	450 x 450	18" x 18"	Ø 400	Ø 16"	
231224	450 x 450	18" x 18"	Ø 450	Ø 18"	
231219	525 x 350	21" x 21"	Ø 400	Ø 16"	
231220	525 x 350	21" x 21"	Ø 450	Ø 18"	

MDO-X - Plastic - Kits No Damper Plastic Clips

Sizes Available/Dimensions				
Item #	Nominal Neck Size		Spigot Size	
	mm	inch	mm	inch
231414	300 x 300	12" x 12"	Ø 200	Ø 8"
231415	300 x 300	12" x 12"	Ø 250	Ø 10"
231416	300 x 300	12" x 12"	Ø 300	Ø 12"
231417	350 x 350	14" x 14"	Ø 300	Ø 12"
231418	350 x 350	14" x 14"	Ø 350	Ø 14"
231429	350 x 350	14" x 14"	Ø 400	Ø 16"
231421	400 x 400	16" x 16"	Ø 350	Ø 14"
231422	400 x 400	16" x 16"	Ø 400	Ø 16"
231423	450 x 450	18" x 18"	Ø 400	Ø 16"
231424	450 x 450	18" x 18"	Ø 450	Ø 18"
231420	525 x 350	21" x 21"	Ø 450	Ø 18"



Neck Adaptor - Plastic

Sizes Available/Dimensions				
Item #	Nominal Neck Size		Spigot Size	
	mm	inch	mm	inch
431056	230 x 230	9" x 9"	Ø 150	Ø 6"
431057	230 x 230	9" x 9"	Ø 200	Ø 8"
431058	300 x 300	12" x 12"	Ø 200	Ø 8"
431059	300 x 300	12" x 12"	Ø 250	Ø 10"
431060	300 x 300	12" x 12"	Ø 300	Ø 12"
431061	350 x 350	14" x 14"	Ø 300	Ø 12"
431062	350 x 350	14" x 14"	Ø 350	Ø 14"
431073	350 x 350	14" x 14"	Ø 400	Ø 16"
431089	350 x 525	14" x 21"	Ø 400	Ø 24"
431090	350 x 525	14" x 21"	Ø 450	Ø 26"
431063	400 x 400	16" x 16"	Ø 350	Ø 14"
431064	400 x 400	16" x 16"	Ø 400	Ø 16"
431065	450 x 450	18" x 18"	Ø 400	Ø 16"
431066	450 x 450	18" x 18"	Ø 450	Ø 18"



Neck Adaptor - Plastic - Butterfly

Sizes Available/Dimensions				
Item #	Nominal Neck Size		Spigot Size	
	mm	inch	mm	inch
431067	230 x 230	9" x 9"	Ø 150	Ø 6"
431068	230 x 230	9" x 9"	Ø 200	Ø 8"
431069	300 x 300	12" x 12"	Ø 200	Ø 8"
431070	300 x 300	12" x 12"	Ø 250	Ø 10"
431071	350 x 350	14" x 14"	Ø 300	Ø 12"

Side Entry Box - Plastic



Side Entry Box - Large



Side Entry Box - Small



Side Entry Box - Small with butterfly

Features

- Manufactured using high grade engineered plastic.
- Suitable for low profile ceilings/confined areas to minimise flow restriction due to sharp bending.
- Snap on connection – no screws or rivets required.
- Twin butterfly damper for balancing airflow.
- Connects to 150 and 200 flex (230 square neck diffuser) or 250 flex (300 square neck diffuser).

Side Entry Box - Plastic

Sizes Available/Dimensions

Item #	Description	Nominal Neck Size		Spigot Size	
		mm	inch	mm	inch
231700	Adaptor MDO Plus Side Entry Kit 150	150 x 150	6" x 6"	N/A	N/A
231701	Adaptor MDO Plus Side Entry Kit 200	200 x 200	8" x 8"	N/A	N/A
231705	Adaptor MDO Plus Side Entry Kit 300	300 x 300	12" x 12"	N/A	N/A
231720	Plastic Side Entry Box 230sq	230 x 230	9" x 9"	N/A	N/A
231721	Plastic Side Entry Neck Adaptor 150 Butterfly	230 x 230	9" x 9"	Ø 150	Ø 6"
231722	Plastic Side Entry Box Neck Adaptor 200	230 x 230	9" x 9"	Ø 200	Ø 8"
231730	Plastic Side Entry Box 300sq	300 x 300	12" x 12"	N/A	N/A
231731	Plastic Side Entry Box Neck Adaptor 250	300 x 300	12" x 12"	≥250	Ø 10"

Opposed Blade Damper (OBD)

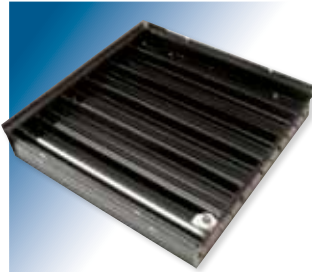

Polyaire Model OBD Opposed Blade Dampers are commonly used as a volume control device in supply, return and exhaust air systems.

Opposed Blade dampers are mounted directly behind the supply, return or exhaust air grille and provide the ability to be manually adjusted through the face of the Diffuser, Grille or Register.

Construction is from either Aluminium or Steel with a matt black finish Model OBD Opposed Blade Dampers are available in stock sizes and can also be manufactured to order in a wide range of sizes.

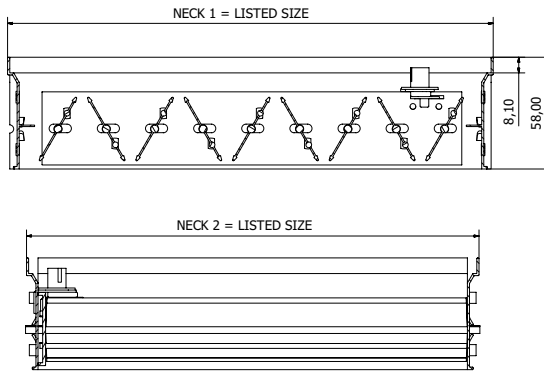

Opposed Blade Dampers - Metal

Sizes Available/Dimensions

Item #	Nominal Neck Size	
	mm	inch
545345	150 x 150	6" x 6"
545646	200 x 100	8" x 4"
545645	200 x 150	8" x 6"
545346	200 x 200	8" x 8"
545644	250 x 150	10" x 6"
545347	250 x 250	10" x 10"
545351	300 x 300	12" x 12"
545353	350 x 350	14" x 14"
545648	450 x 450	18" x 18"

Outside Air Louvre



Polyaire Model OAL Outside Air Louvres are designed to provide weather protection of outside air or discharge openings yet to allow free passage of air. These external Louvres may also be used for natural ventilation.

Polyaire manufacture both a small section and a large section outside air louvre as detailed below. The Polyaire Small Section Outside Air Louvre model OAL-S is normally used for small sizes and small air quantities.

Construction is from all extruded aluminium with a standard flange of 32mm.

A Bird screen of 12mm x 12mm square mesh is fitted to the rear as an option.

Standard finish is natural anodised while other finishes including powder coat are available to suit the interior and architectural design requirements.

Model OAL-S Outside Air Louvres are available in stock sizes and can also be manufactured to order in a wide range of sizes.

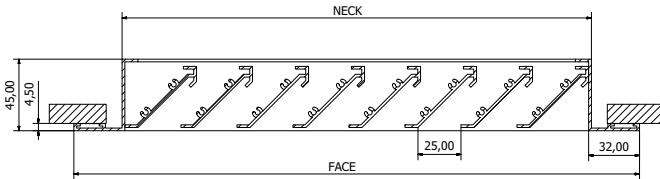

Outside Air Louvre - Metal

Sizes Available/Dimensions

Item #	Nominal Neck Size		Face Size	
	mm	inch	mm	inch
244403	150 x 150	6" x 6"	204 x 204	8" x 8"
244000	200 x 200	8" x 8"	254 x 254	10" x 10"
244404	230 x 180	9" x 7"	284 x 234	11" x 9"
244001	250 x 250	10" x 10"	304 x 304	12" x 12"
245423	300 x 250	12" x 10"	354 x 304	14" x 12"
244002	300 x 300	12" x 12"	354 x 354	14" x 14"
244003	350 x 350	14" x 14"	404 x 404	16" x 16"
244004	400 x 400	16" x 16"	454 x 454	18" x 18"
244244	500 x 500	20" x 20"	554 x 554	22" x 22"
244245	600 x 300	24" x 12"	654 x 354	26" x 14"
244246	600 x 400	24" x 16"	654 x 454	26" x 18"
244247	600 x 600	24" x 24"	654 x 654	26" x 26"

Outside Air Louvre - Round



Outside Air Louvre - Round

Description

Model	Description
244010	OUTSIDE AIR LOUVRE GRILLE ROUND 150 X 150
244011	OUTSIDE AIR LOUVRE GRILLE ROUND 200 X 200

RAG-H Return Air Grille



The RAG-H from Polyaire has been specifically developed as the complete solution for a return air grille in almost all ducted heating applications.

The ceiling mount kits are complete with grille, return air box, clips and neck adaptor to suit either 300mm, 350mm or 400mm duct.

The wall mount kit comprises grille and metal installation frame.

RAG-H - Plastic - Components

Sizes Available/Dimensions					
Item #	Description	Nominal Neck Size		Face Size Metric	
		mm	inch	mm	inch
231125	RAG-H Kit 350 x 900 Frame + Grille	350 x 900	14" x 35"	950 x 390	37" x 15"
231150	RAG-H 370 x 520 Grille Only	370 x 520	15" x 21"	425 x 575	17" x 23"
231160	RAG-H 350 x 900 x 35 Grille Only	350 x 900	14" x 35"	950 x 390	37" x 15"
231630	RAG-H Box 370 x 520 Only	370 x 520	15" x 21"	N/A	N/A
442654	RAG-H Supp Frame 350 x 900	350 x 900	14" x 36"	N/A	N/A
442655	RAG-H supp frame 410 x 560	410 x 560	16" x 22"	N/A	N/A
664404	Filter RAG-H 325 x 885 Only	N/A	N/A	325 x 885 x 11	13" x 35" x 0.4"
664405	Filter RAG-H 360 x 610 Only	N/A	N/A	360 x 610	14" x 24"

RAG-H - Plastic - Kits

Sizes Available/Dimensions	
Item #	Description
231117	370 x 520 Kit to suit 300mm Duct <i>Components: RAG-H Grille, RAG-H Box, Neck Adaptor 350/300, Metal Mounting Clips</i>
231118	370 x 520 Kit to suit 350mm Duct <i>Components: RAG-H Grille, RAG-H Box, Neck Adaptor 350/350, Metal Mounting Clips</i>
231119	370 x 520 Kit to suit 400mm Duct <i>Components: RAG-H Grille, RAG-H Box, Neck Adaptor 350/400, Metal Mounting Clips</i>
231120	370 x 520 Grille + Mounting Frame Kit <i>Components: RAG-H Grille, RAG Metal Frame, Metal Mounting Clips</i>
231125	370 x 900 Grille + Mounting Frame Kit <i>Components: RAG-H Grille, RAG Metal Frame, Metal Mounting Clips</i>
231170	400 x 750 Grille + Filter + Mounting Frame Kit <i>Components: RAG-H Grille, Filter RAG Metal Frame, Metal Mounting Clips</i>
231175	350 x 1200 Grille + Mounting Frame Kit <i>Components: RAG-H Grille, RAG Metal Frame, Metal Mounting Clips</i>

RAG-X Return Air Grille

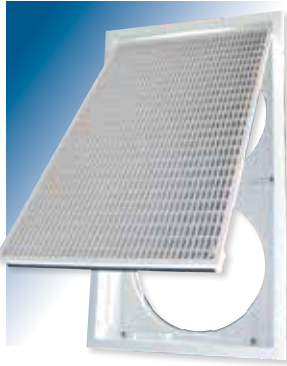

900 x 500 &
1195 x 595mm



750 x 450mm

The RAG-X from Polyaire is an injection moulded high strength plastic complete Return Air assembly designed for more efficient installation, operation and maintenance.

The RAG-X one piece construction provides a significantly improved appearance compared to traditional grilles. It is simpler and easier to fit and reduces installation time.

Features include:

- Tri Filter for efficient dust removal.
- High Efficiency Low Static Filter.
- Black filter to reduce see through effect.
- Easy filter and grille removal for cleaning or replacement.
- Large free area for quiet efficient air flow.
- Aluminium Filter Frame.
- Grille release clips are hidden from view but are still instantly accessible.
- Grille opening can be reversed for ease of use.
- Attractive Eggcrate grille design.
- Rigid return air box.
- Simple clip in installation.
- Clip on reducers easily accommodate varying duct sizes.

Installation features:

- 750 x 450/1 x 400mm Round Connector.
- 900 x 500/2 x 400mm Round Connector.
- 1195 x 595/2 x 400mm Round Connector.
- Rigid one piece shell for easy fitment.
- Quick & easy duct attachment with standard Quick Fix Spigot or Reducer. (Fit the Duct to the collar and then clip on in the roof).
- Easy attachment to ceiling with wing nut adjustment (No tools needed).
- Sturdy metal wire clips for long life and no sagging.
- Filter Grille fits either way & swings out for easy cleaning.
- Front Grille Clips are positive locking & easy to use.
- Large free area.
- Simple slide in/out filter.
- More air flow efficient egg crate grille style.

Construction:

- One piece moulded return air box for strength, no leaks, low noise.
- All plastic for long life, low noise and corrosion/rust resistance.
- Reversible grille for easy use.
- Removable Tri Filter.
- Aluminium frame filter.

RAG-X Return Air Grille

RAG-X - Plastic - Box Only

Sizes Available/Dimensions						
Item #	Nominal Neck Size		Face Size		Spigot Size	
	mm	inch	mm	inch	mm	inch
231600	750 x 450	30" x 18"	806 x 506	32" x 20"	Ø400	Ø16"
231610	900 x 500	35" x 20"	956 x 556	38" x 22"	2 x Ø400	2 x Ø16"
231620	1139 x 539	45" x 21"	1195 x 595	47" x 23"	2 x Ø400	2 x Ø16"

RAG-X - Plastic - Grille Only

Sizes Available/Dimensions					
Item #	Nominal Neck Size		Face Size		inch
	mm	inch	mm	inch	
231135	750 x 450	30" x 18"	806 x 506	32" x 20"	
231137	900 x 500	35" x 20"	956 x 556	38" x 22"	
231140	1139 x 539	45" x 21"	1195 x 595	47" x 23"	

RAG-X - Plastic - Kits

Sizes Available/Dimensions						
Item #	Nominal Neck Size		Face Size		Spigot Size	
	mm	inch	mm	inch	mm	inch
231520	750 x 450	30" x 18"	806 x 506	32" x 20"	Ø400	Ø16"
<i>Components: RAG-X Grille inc Filter 750 x 450, RAG-X Box 750 x 450, QFF Spigot 400mm</i>						
231521	750 x 450	30" x 18"	806 x 506	32" x 20"	Ø350	Ø14" (Reducer)
<i>Components: RAG-X Grille inc Filter 750 x 450, RAG-X Box 750 x 450, QFF Spigot 350mm</i>						
231530	900 x 500	35" x 20"	956 x 556	38" x 22"	2 x Ø400	Ø16"
<i>Components: RAG-X Grille inc Filter 900 x 500, RAG-X Box 900 x 500, QFF Spigot 400mm</i>						
231531	900 x 500	35" x 20"	956 x 556	38" x 22"	2 x Ø350	Ø14" (Reducer)
<i>Components: RAG-X Grille inc Filter 900 x 500, RAG-X Box 900 x 500, QFF Spigot 350mm</i>						
231540	1139 x 539	45" x 21"	1195 x 595	14" x 23"	2 x Ø400	Ø16"
<i>Components: RAG-X Grille inc Filter 1195 x 595, RAG-X Box 1195 x 595, QFF Spigot 400mm</i>						
231541	1139 x 539	45" x 21"	1195 x 595	14" x 23"	2 x Ø350	Ø14" (Reducer)
<i>Components: RAG-X Grille inc Filter 1195 x 595, RAG-X Box 1195 x 595, QFF Spigot 350mm</i>						

Quick Fix Fitting - Spigots

Sizes Available/Dimensions					
Item #	Description	Type	Size		
			mm	inch	
340382	Quick Fix Spigot	(Half - 2 required)	250	10"	
340383	Quick Fix Spigot	(Half - 2 required)	300	12"	
340384	Quick Fix Spigot	(Half - 2 required)	350	14"	
340385	Quick Fix Spigot	(Half - 2 required)	400	16"	
340386	Quick Fix Spigot	(Half - 2 required)	450	18"	

Round Ceiling Diffuser



The standard Polyaire Round Ceiling Diffuser is manufactured from high impact ABS for long term strength and rigidity. It is fully adjustable by rotating the centre cone from total shutoff to fully open.

The standard colour is off-white, the outer surface is lightly etched to reduce reflection and fit unobtrusively with most decors. Available in 4 sizes, it allows for smooth quiet airflow that flows out in a concentric pattern across the ceiling, to provide good coverage in cooling and most heating applications.

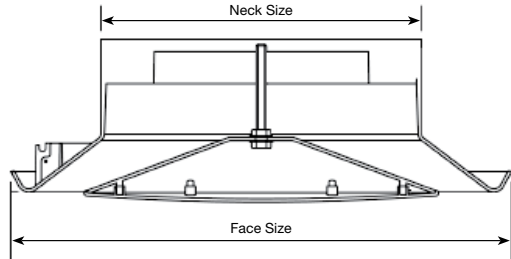

Round Ceiling Diffuser - Plastic

Sizes Available/Dimensions				
Item #	Nominal Neck Size		Face Size	
	mm	inch	mm	inch
235384	Ø 150	Ø 6"	Ø 265	Ø 10"
237100	Ø 200	Ø 8"	Ø 318	Ø 13"
237101	Ø 250	Ø 10"	Ø 390	Ø 15"
237102	Ø 300	Ø 12"	Ø 441	Ø 17"

Round Ceiling Diffuser - Plastic - Insulated

Sizes Available/Dimensions				
Item #	Nominal Neck Size		Face Size	
	mm	inch	mm	inch
235280	Ø 200	Ø 8"	Ø 318	Ø 13"
235281	Ø 250	Ø 10"	Ø 390	Ø 15"
235282	Ø 300	Ø 12"	Ø 441	Ø 17"



Round Ceiling Diffuser - Aluminium - PA Plate

Sizes Available/Dimensions				
Item #	Nominal Neck Size		Face Size	
	mm	inch	mm	inch
245270	Ø 150	Ø 6"	Ø 320	Ø 13"
245271	Ø 200	Ø 8"	Ø 412	Ø 16"
245272	Ø 250	Ø 10"	Ø 480	Ø 19"
245273	Ø 300	Ø 12"	Ø 550	Ø 22"

Round Heritage Outlet



The Circular Heritage Outlet is a more decorative design that employs a unique three stage regulation from closed through partially open to full open so that airflow needs can be tailored for a wide variety of applications.

Round Heritage Outlet - Plastic

Sizes Available/Dimensions

Item #	Nominal Neck Size		Face Size	
	mm	inch	mm	inch
231085	Ø 150	Ø 6"	Ø 240	Ø 9"
231086	Ø 200	Ø 8"	Ø 285	Ø 11"
231087	Ø 250	Ø 10"	Ø 340	Ø 13"
231088	Ø 300	Ø 12"	Ø 390	Ø 15"

Round Outlet - Multi Cone Diffusers



Round Ceiling Diffuser - Aluminium - Multi Cone Style

Sizes Available/Dimensions

Item #	Nominal Neck Size		Face Size	
	mm	inch	mm	inch
245284	Ø 150	Ø 6"	Ø 320	Ø 13"
245285	Ø 200	Ø 8"	Ø 412	Ø 16"
245286	Ø 250	Ø 10"	Ø 480	Ø 19"
245287	Ø 300	Ø 12"	Ø 550	Ø 22"
245288	Ø 350	Ø 14"	Ø 595	Ø 24"

Roundjet - Plastic



The Polyaire Roundjet is designed to jet the airflow right down to the floor which aids in mixing and circulating the air.

It is particularly efficient for rooms with higher ceilings and stairwells where a stronger more direct flow is required to get to the floor level and mix properly.

Features

- Flush mounting
- Easy clean non reflective white surface
- 2 sizes, 150mm & 200mm
- Fully adjustable flow from complete shut off to fully open
- Constructed from ABS for long term strength and stability

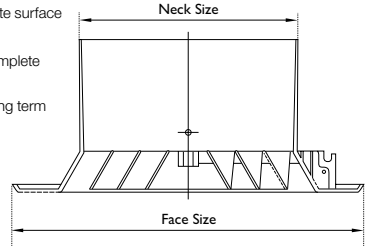

Roundjet - Plastic

Sizes Available/Dimensions

Item #	Nominal Neck Size		Face Size	
	mm	inch	mm	inch
235446	Ø 150	Ø 6"	Ø 240	Ø 9"
235447	Ø 200	Ø 8"	Ø 290	Ø 11"

Braemar
HEATING COOLING

*Gas Heating &
Evaporative Cooling*



Polyaire supplies a complete range of Braemar heating and cooling products which are outstanding in quality, reliable and provides superior comfort that has stood the test of time.

Distributed by **polyaire**

Security Relief Grille



The Polyaire Security Relief Vent offers the optimum solution for the increasing market popularity of evaporative air conditioning systems. The Security Relief Vent simply replaces the need to have doors or windows open to allow for the discharge of air during operation of evaporative systems.

The Security Relief Vent provides for cool air to be directed into the roof space which has a secondary cooling benefit and ensures that the energy required for cooling is not lost.

The Security Relief Vent can be added to existing installations as required or included in the design of any new or proposed work.

Available in one convenient size to suit all applications the Security Relief Vent permits doors and windows to remain locked whilst maximising the benefits of evaporative air conditioning systems.

Security Relief Grille

Sizes Available/Dimensions

Item #	Nominal Neck Size		Face Size	
	mm	inch	mm	inch
231079	525 x 350	21" x 14"	565 x 390	22" x 15"
231054	Mounting Clips - New (4) Metal			

Silent Air Grille



The unique cellular design of the Silent Air ceiling diffuser is the key to smooth turbulence free air diffusion.

The design allows for an exceptionally smooth air path where above average air volumes are required, providing low turbulence and reduced noise levels.

Designed specifically for commercial high rise application, the Silent Air diffuser has a stylish appeal which integrates with all ceiling styles, blending perfectly with modern interior designs and lighting decor. A strong lightweight construction with snap in diffuser quadrants, the Silent Air diffuser allows easy access for cleaning in high traffic areas.

Made from ABS material, the Silent Air diffuser will not fade, stain or corrode and is ideally suited for installation in tropical areas.

Silent Air Grille

Sizes Available/Dimensions

Item #	Nominal Neck Size		Face Size	
	mm	inch	mm	inch
231082	495 x 495	20" x 20"	595 x 595	23" x 23"

Square Swirl Diffusers - Model PSA

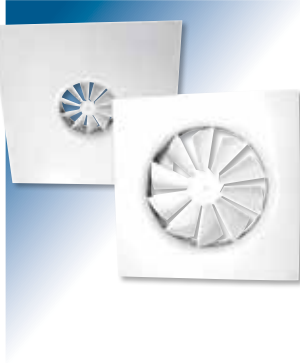

The Polyaire PSA Swirl Diffuser promotes high entrainment of ambient air into the supply air stream. The helical airflow reduces air velocity and provides a consistent spread resulting in relatively uniform temperature, humidity and air quality in all parts of the occupied space.

During cooling the warmest air in the room is immediately mixed with the supply air and temperature variation around the space (hot & cold spots) is minimised. During heating, the high induction of the room air by the supply swirl ensures sufficient air diffusion to minimise stratification and stagnant areas in the space. They are suitable for use in both constant volume flow and VAV systems and are suitable for all types of installation in closed ceilings, above open grid ceilings and in ceiling panels.

The standard PSA is made of cold rolled galvanized plate steel powder coated white (RAL9010). Other finishes are available to suit the interior and architectural design requirements. The face plate is 595mm square and suitable for surface mounting in the ceiling or alternatively as a lay-in for T-Bar ceiling installations.

Square Swirl Diffusers - Metal - Model PSA

Sizes Available/Dimensions

Item #	Face Size/Neck Size (mm)	Q		A		V	
		mm	inch	mm	inch	mm	inch
247090	PSA Q 595/198	595	23"	198	8"	120	5"
247091	PSA Q 595/248	595	23"	248	10"	120	5"
247092	PSA Q 595/313	595	23"	313	12"	125	5"
247093	PSA Q 595/398	595	23"	398	16"	125	5"

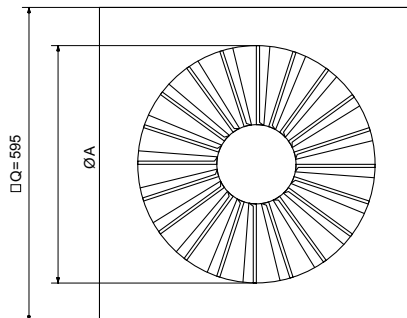
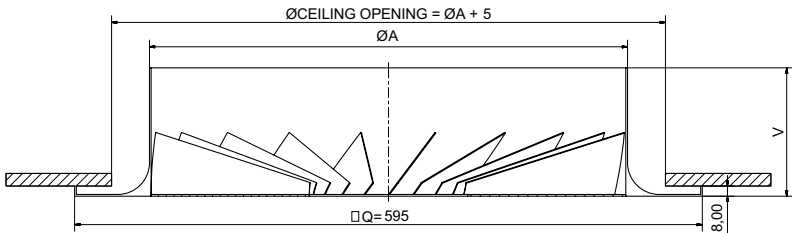

Square Swirl Diffusers - Model PSB



The Polyaire PSB Swirl Diffuser has fixed spiral blades that create rotational as well as axial, tangential and radial air movement. This means that it produces a strong horizontal swirl, obtaining high inductivity, to allow the introduced flow to rapidly mix with the ambient air to reduce temperature and also perceived drafts or hot/cold spots.

Velocity is reduced while still maintaining volume and reduced noise and this product is ideally suited to handling large volumes. The PSB maintains high quality air diffusion throughout the space with minimal temperature variation. The Swirl effects ensure good mixing of supply and ambient air.

The PSB is also suitable for return air application due to low pressure drop across the grille. The standard PSB is made of cold rolled galvanized plate steel powder coated white (RAL9010) Other finishes are available to suit the interior and architectural design requirements. The face plate is 595mm square and suitable for surface mounting in the ceiling or alternatively as a lay-in for T-Bar ceiling installations.

Square Swirl Diffusers - Metal - Model PSB

Sizes Available/Dimensions

Item #	Face Size/Neck Size (mm)	Q		L	
		mm	inch	mm	inch
247094	PSB Q 595/254	595	23"	254	10"
247095	PSB Q 595/336	595	23"	336	13"
247096	PSB Q 595/440	595	23"	440	17"
247097	PSB Q 595/530	595	23"	530	21"

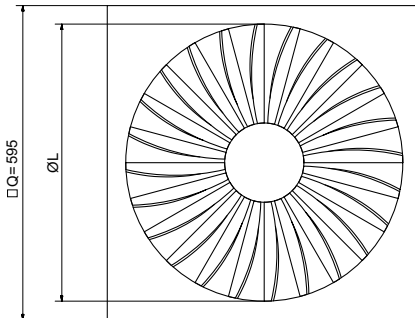
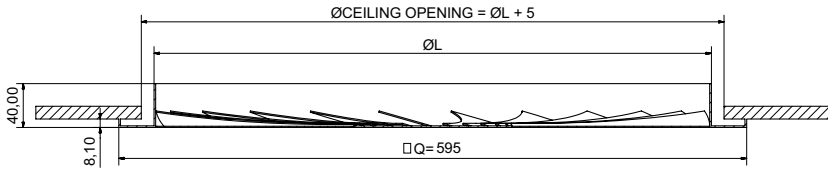

Square Swirl Diffusers - Model PSC

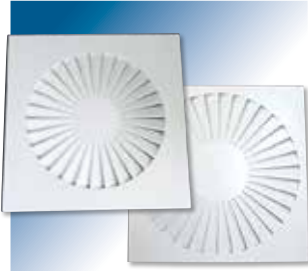

The Polyaire PSC Swirl Diffuser has fixed blades that create rotational as well as axial, tangential and radial air movement. This means that it produces a strong horizontal swirl, obtaining high inductivity, to allow the introduced flow to rapidly mix with the ambient air to reduce temperature and also perceived drafts or hot/cold spots.

Velocity is reduced while still maintaining volume and reduced noise and this product is ideally suited to handling large volumes. The PSC maintains high quality air diffusion throughout the space with minimal temperature variation. The Swirl effects ensure good mixing of supply and ambient air. The PSC is also suitable for return air application due to low pressure drop across the grille.

The standard PSC is made of cold rolled galvanized plate steel powder coated white (RAL9010) Other finishes are available to suit the interior and architectural design requirements. The face plate is 595mm square and suitable for surface mounting in the ceiling or alternatively as a lay-in for T-Bar ceiling installations.

Square Swirl Diffusers - Metal - Model PSC

Sizes Available/Dimensions						
Item #	Face Size/Neck Size (mm)	Q		L		
		mm	inch	mm	inch	
247101	PSC Q 595/535	595	23"	535	21"	
247102	PSC R - HIGH VOL 675/500	675	23"	500	20"	
247103	PSC Q - HIGH VOL 595/500	595	23"	500	20"	
247104	SWIRL DIF 24 ADJ BLADE Q 595/538	595	23"	538	21"	
247105	PSC Q - HIGH VOL 595/350	595	23"	350	14"	
247106	PSC R 600D/535	600	24"	535	21"	
247107	PSC Q - HIGH VOL SWL DIF 395/350	395	16"	350	14"	
247108	PSC Q - HIGH VOL SWL DIF 445/350	445	18"	350	14"	
247109	PSC Q - HIGH VOL SWL DIF 495/350	495	20"	350	14"	
247110	PSC Q - HIGH VOL SWL DIF 470D/350	470	19"	350	14"	

