



# TOSHIBA LIGHT COMMERCIAL SYSTEMS

Providing endless possibilities



# WHY CHOOSE TOSHIBA AIR CONDITIONERS?

Being comfortable in your environment means much more than controlling the temperature. Toshiba air conditioners are designed for flexibility in application with low operating noise and improved air quality, and above all, reliability. So, you get all year-round comfort plus accurate temperature control.

## FLEXIBLE RANGE

Whether you are looking to cool a small bedroom or a office boardroom, the range of Toshiba's residential air conditioning solutions are ideal for all areas of your home or office. From wall mounted split systems to inverter ducted systems or under ceiling system, Toshiba has a wide variety of heating and cooling solutions to suit your requirements.

## AFTER SALES SERVICE

Problems tend to happen when you least expect them. Our in-house technical support team is unlike any other and it's easy to know why.

You can count on our in-house technical support to assist you with anything you may need. We take this duty very seriously, so you can rest assured you will have dependable, ongoing support every time.

## PEACE OF MIND

At Toshiba, we are confident our air conditioners can withstand the harsh conditions of the Australian climate, which is why we offer an extended 7-year warranty across our entire range of air conditioning products, Australia-wide for all residential applications.



# REDUCING GWP WITH R32

Our world is as precious as it is delicate, it's our responsibility to help take care of it.

Air conditioners circulate refrigerants to cool and heat air, recently some of these gases have been linked with environmental issues such as ozone depletion and climate change.

Choosing the right refrigerant requires consideration of all related issues and a holistic approach. It needs to be safe, but it also needs to be economical, efficient, and environmentally responsible.

R32 systems are more efficient as they require less refrigerant than R410a systems and because R32 is not mixed with other refrigerants, it can be recycled.

Using R32, we offer a better refrigerant combined with Toshiba's renowned high-level of performance and efficiency.

**GWP = Global Warming Potential**



# TABLE OF CONTENTS

---

Toshiba Technology	04
Digital Inverter [DI]	06
Super Digital Inverter [SDI]	08
Compact 4-Way Cassette	10
4-Way Cassette	12
High Wall	14
Mid-Static Ducted	16
High Static Ducted	18
Under Ceiling	20
Controls	22

# TOSHIBA'S TWIN ROTARY COMPRESSOR

Toshiba's Twin Rotary compressor brings outstanding performance without compromising on system reliability.

## TWIN ROTARY COMPRESSOR

Our proprietary Toshiba Twin Rotary compressor and inverter provide optimum control for maximising performance efficiency. With a rotor in each compression chamber, Toshiba Twin Rotary compressor systems are compact, lightweight, and low vibration while requiring less space for installation.

## DLC TREATMENT

Toshiba's Diamond Like Carbon coating technology is unique to Toshiba's compressors.

It covers the wear surfaces on compression vanes for outstanding hardness and wear resistance, enhancing both the compressor's performance and durability.



Large capacity



Wide operating range



DLC Treatment  
[Diamond Like Carbon]

# TOSHIBA TECHNOLOGY

## PAM

Pulse Amplitude Modulation [PAM] is a technology that controls the current waveform so that it resembles the supply voltage wave, thereby reducing loss and realising more efficient use of electricity.

With a PAM inverter, the voltage delivered to the compressor could be increased as needed, resulting in increased rotation speed.

Using PAM control, 98% of the input power supply is used effectively.

## PWM

Pulse Width Modulation [PWM] helps to balance the compressor speed revolution, either higher speed when providing fast cooling, or slow speed when maintaining room temperature resulting in significantly reduced consumption.

## INVERTER CONTROL

The inverter component allows for the Toshiba outdoor unit to vary its speed and output to match the required capacity of the indoor unit. Thus, the unit can achieve 30% more operating efficiency than conventional models and therefore, is more economical to run.

The background image shows two women sitting at a wooden table in a bright, modern office or meeting room. They are both smiling and looking at a laptop. One woman is pointing at the screen while the other looks on. There are papers, a color calibration chart, and a glass of water on the table. Large windows in the background let in natural light, showing an outdoor area with plants.

**TOSHIBA**

**AIR CONDITIONING**

## COMMITTED TO DEVELOPMENT & COMFORT

---

### ABSOLUTE COMFORT

Toshiba's commitment to society drives a company-wide focus on attention to details through every stage of the development process, from design to user field tests, installations using our products and systems therefore featuring higher standard of indoor air quality, sound levels and energy savings when compared to its predecessors,

# DIGITAL INVERTER

## GM SERIES

A full range of Toshiba R32 light commercial systems are now available with Digital Inverter combinations to suit an array of application types, whether it be for residential or commercial spaces.

The technology of the Digital Inverter control module ensures optimised reproduction of the supply sine wave at the desired frequency in order to reduce inefficient harmonics that inverters normally emit.

With this innovative control method, Toshiba's Digital Inverter brings state-of-the-art inverter technology to its light commercial range, offering considerable advantages from wide capacity range, energy efficiencies to optimised comfort.

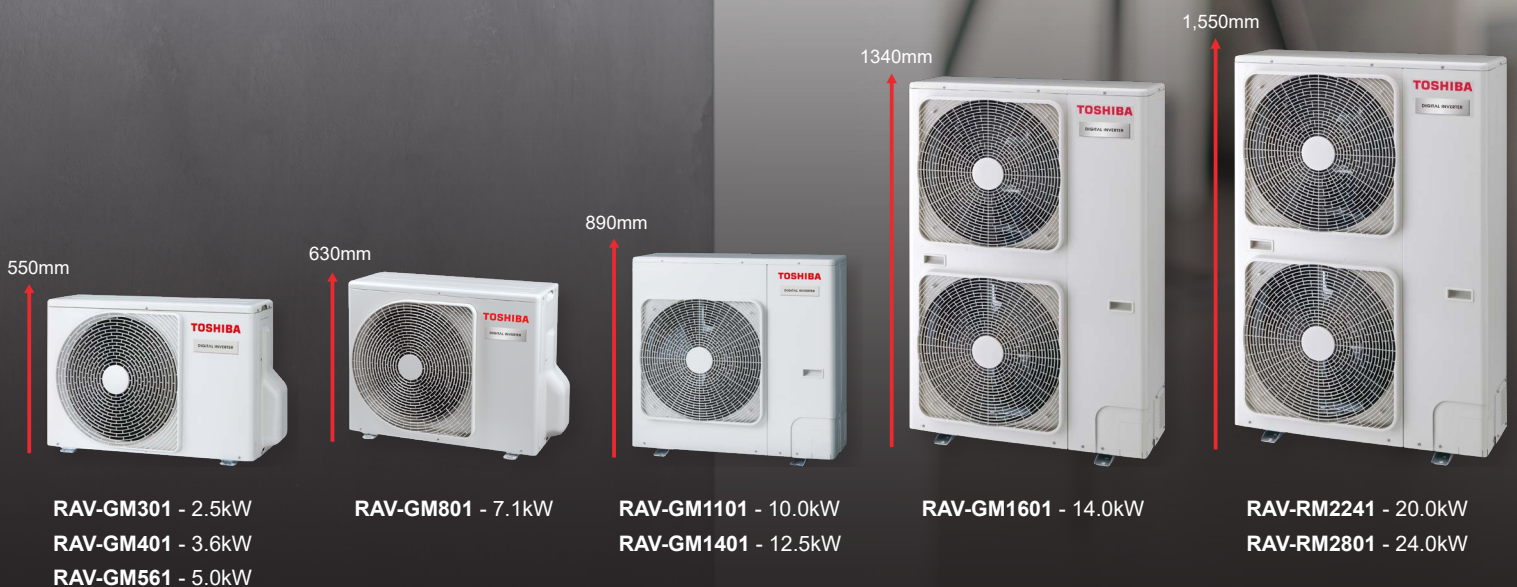

## COMPACT CHASSIS

Single fan outdoor units are available from 2.5kw through to 12.5kw with a compact height of less than 900mm, making them an ideal unit for commercial applications where space may be a constraint. Being compact also enables these units to be double stacked without compromising on performance.



# DIGITAL INVERTER [DI] LINE-UP

## DIGITAL INVERTER [DI]

							
SINGLE PHASE OUTDOOR	RAV-GM301ATP-A	RAV-GM401ATP-A	RAV-GM561ATP-A	RAV-GM801ATP-A	RAV-GM1101ATP-A	RAV-GM1401ATP-A	RAV-GM1601ATP-A
THREE PHASE OUTDOOR	-	-	-	-	-	-	RAV-GM1601AT8P-A

## COMPACT 4-WAY CASSETTE

	RAV-RM301MUT-E	RAV-RM401MUT-E	RAV-RM561MUT-E	N/A	N/A	N/A	N/A
---	----------------	----------------	----------------	-----	-----	-----	-----

## 4-WAY CASSETTE

	N/A	N/A	RAV-GM561UTP-A	RAV-GM801UTP-A	RAV-GM1101UTP-A	RAV-GM1401UTP-A	RAV-GM1601UTP-A
--	-----	-----	----------------	----------------	-----------------	-----------------	-----------------

## HIGH WALLS

	RAV-GM301KRTP-A	RAV-GM401KRTP-A	RAV-GM561KRTP-A	RAV-GM801KRTP-A	N/A	N/A	N/A
---	-----------------	-----------------	-----------------	-----------------	-----	-----	-----

## MID-STATIC DUCTED

	N/A	N/A	RAV-GM561BTP-A	RAV-GM801BTP-A	RAV-GM1101BTP-A	RAV-GM1401BTP-A	RAV-GM1601BTP-A
---	-----	-----	----------------	----------------	-----------------	-----------------	-----------------

## HIGH STATIC DUCTED

	N/A	N/A	RAV-GM561DTP-A	RAV-GM801DTP-A	RAV-GM1101DTP-A	RAV-GM1401DTP-A	RAV-GM1601DTP-A
---	-----	-----	----------------	----------------	-----------------	-----------------	-----------------

## UNDER CEILING

	N/A	N/A	RAV-GM561CTP-A	RAV-GM801CTP-A	RAV-GM1101CTP-A	RAV-GM1401CTP-A	RAV-GM1601CTP-A
---	-----	-----	----------------	----------------	-----------------	-----------------	-----------------

## DIGITAL INVERTER [DI]

		
THREE PHASE OUTDOOR	RAV-GM2241AT8-A	RAV-GM2801AT8-A

## HIGH STATIC DUCTED

	RAV-RM2241DTP-E2	RAV-RM2801DTP-E2
---	------------------	------------------

# SUPER DIGITAL INVERTER

## GP SERIES

The expectations of a modern air conditioning system have evolved over the past years. Today, advanced comfort goes hand in hand with reduced energy and maintenance costs, combined with maximised simplicity and true operational flexibility.

The Super Digital Inverter associates all of Toshiba's innovative spirit and outstanding expertise to create highly efficient solutions with maximum end user comfort at its core.

Toshiba Super Digital air conditioners combine economy and ecology in a compact body. They feature Toshiba's state-of-the-art technology, flexible control, and easy installation to bring natural comfort and convenience to any home or business environment.

## PIPING FLEXIBILITY

Toshiba's Super Digital Inverter series supports height differences of up to 30 meters on a single system, which is enough height to cover an 8 storey building.

The SDI series also boasts up to 75 meters of allowable pipe run, increasing installation flexibility, making it possible to use in just about any application.





# ECO-DRIVING DC TWIN ROTARY

**High efficiency heat-transfer**

Heat-transfer tube with improved heat-transfer coefficient.

**DC fan motor**

Highly efficient DC Motor.

**Bat wing fan**

Newly development for high-pressure low-volume fan.

**Wide-flow grille**

Optimising ventilation performance, bringing out the full effect of fan and motor.

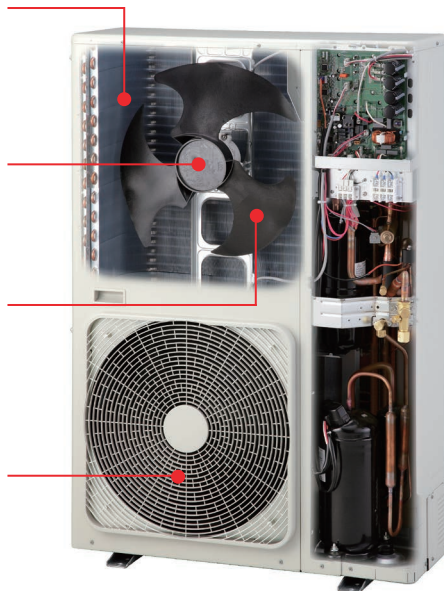

**PIPING FLEXIBILITY**

A low minimum speed of 10 rps has been achieved. This has further improved the operating efficiency when the load is low.

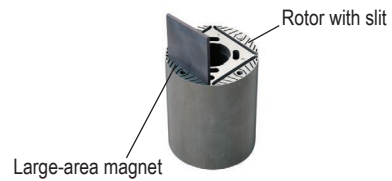

The structure and shape of each compressor component has been optimised. The area of the rotor magnet has been increased and a slit introduced to the design. These improvements have further enhanced efficiency and reduced noise.

**SUPER DIGITAL INVERTER [SDI]**

SINGLE PHASE OUTDOOR	RAV-GP561ATP-A	RAV-GP801ATP-A	RAV-GP1101ATP-A	RAV-GP1401ATP-A	RAV-GP1601ATP-A
THREE PHASE OUTDOOR	-	-	RAV-GP1101AT8P-A	RAV-GP1401AT8P-A	RAV-GP1601AT8P-A

	4-WAY CASSETTE				
	RAV-GM561UTP-A	RAV-GM801UTP-A	RAV-GM1101UTP-A	RAV-GM1401UTP-A	RAV-GM1601UTP-A

	HIGH WALLS				
	RAV-GM561KRTP-A	RAV-GM801KRTP-A	N/A	N/A	N/A

	MID-STATIC DUCTED				
	RAV-GM561BTP-A	RAV-GM801BTP-A	RAV-GM1101BTP-A	RAV-GM1401BTP-A	RAV-GM1601BTP-A

	HIGH STATIC DUCTED				
	RAV-GM561DTP-A	RAV-GM801DTP-A	RAV-GM1101DTP-A	RAV-GM1401DTP-A	RAV-GM1601DTP-A

	UNDER CEILING				
	RAV-GM561CTP-A	RAV-GM801CTP-A	RAV-GM1101CTP-A	RAV-GM1401CTP-A	RAV-GM1601CTP-A

# COMPACT 4-WAY CASSETTE

## PERFECT FOR GRID SYSTEM CEILING

This compact unit (575 x 575 mm) fits perfectly into ceilings and matches standard architectural modules, without the need to cut ceiling tiles.

## COMFORT

Individual louver control enables airflow to be chosen according to user preferences. The angles of each louver can be set individually in 3 different choices of swing patterns; Standard swing, Diagonally opposite swing and Turn-around swing

## EASE OF INSTALLATION & MAINTENANCE

The slim flat stylish panel design is only 270 mm in height even when an electrical box is located inside the unit. Easy access to electrical box is achieved by simply removing the suction grill.

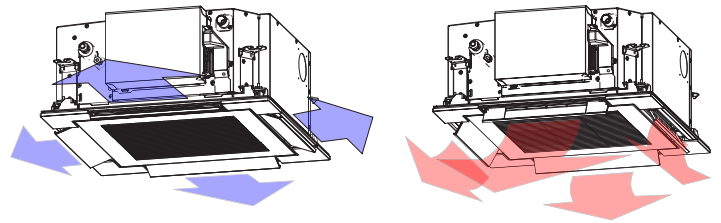

## BUILT-IN CONDENSATE DRAIN PUMP

Equipped with a built-in drain pump with a pressure lift of 850mm, increasing flexibility and installation speed.

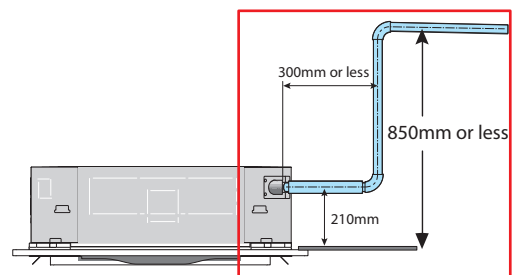

## SELF CLEAN MODE

The unit dries internally by running on FAN operation once normal cycle has ceased, allowing the unit to be kept clean and reducing the built up of allergens, dust and odours.

# COMPACT 4-WAY CASSETTE SPECIFICATIONS

INDOOR UNIT		RAV-RM301MUT-E	RAV-RM401MUT-E	RAV-RM561MUT-E
OUTDOOR UNIT		RAV-GM301ATP-A	RAV-GM401ATP-A	RAV-GM561ATP-A
Cooling Capacity Range	kW	2.50 [0.90 - 3.00]	3.60 [0.90 - 4.00]	5.00 [1.50 - 5.60]
Heating Capacity Range	kW	3.40 [0.80 - 4.50]	4.00 [0.80 - 5.00]	5.30 [1.50 - 6.30]
EER		4.24	4.00	3.23
COP		4.47	4.00	5.30
Maximum Operating Current	A	7.90	9.20	15.50
Dimensions - Indoor [H x W x D]		256 x 575 x 575	256 x 575 x 575	256 x 575 x 575
Dimensions - Outdoor [H x W x D]	mm	550 x 780 x 290	550 x 780 x 290	550 x 780 x 290
Dimensions - Panel [H x W x D]		12 x 620 x 620	12 x 620 x 620	12 x 620 x 620
Weight - Indoor / Outdoor / Panel	kg	15 / 29 / 2.5	15 / 34 / 2.5	15 / 40 / 2.5
Airflow [H / M / L]	l/s	177 / 144 / 122	183 / 169 / 153	221 / 186 / 151
Sound Pressure Level Indoor / Outdoor	dB(A)	38 / 47	41 / 50	44 / 48
Operating Range Cooling	°C db	-15 to 46	-15 to 46	-15 to 46
Operating Range Heating		-15 to 15	-15 to 15	-15 to 15
Pipe Sizes (Liquid / Gas)	mm	6.35 / 9.52	6.35 / 12.70	6.35 / 12.70
Maximum Pipe Length / Lift	m	20 / 10	20 / 10	30 / 30
Maximum Pre-charged Length		15	15	20
Power Supply	Ph / V / Hz	1ph / 220-240V / 50Hz	1ph / 220-240V / 50Hz	1ph / 220-240V / 50Hz

Refer to the Engineering Databook for details on these conditions and requirements.

Rate conditions: Cooling: Indoor 27 °C Dry Bulb / 19 °C Wet Bulb, Outdoor 35 °C Dry Bulb.  
Heating: Indoor 20 °C Dry Bulb, Outdoor 7 °C Dry Bulb / 6 °C Wet Bulb.  
Base on equivalent piping length of 7.5m and piping height difference of 0m.

## CONTROLS OPTIONS



### BACKLIT WIRED CONTROLLER

**RBC-AMS55E-ES / RBC-AMSU51-ES**

The ultimate in local controller with built-in 7-day timer, large screen and easy to use menu.

#### FUNCTIONS:

- On / Off
- Schedule timer
- Holiday mode
- Dual set point
- Energy saving operation
- Night operation (only with models equipped with the function)
- Temperature increments of 0.5°C



### COMPACT WIRED CONTROLLER

**RBC-ASC11E / RBC-ASCU11-E**

Back to basics with this remote controller offering all the standard functionalities with compact dimensions and a large screen.

#### FUNCTIONS:

- On / Off
- Operation mode
- Temperature setting
- Fan speed
- Louvres
- Fault codes
- Unit setup



### STANDARD WIRED CONTROLLER

**RBC-AMT32E / RBC-AMS41E**

The standard remote controller to control an individual indoor unit or a group of 8 indoor units.

#### FUNCTIONS:

- On / Off
- Operation mode
- Temperature setting
- Fan speed
- Louvres
- Fault codes
- Unit setup
- Button restrictions



### WIRELESS CONTROLLER KIT

**RBC-AXU31UM-E**

The wireless infra-red remote controller kit features an easy to use and compact button layout along with standard control buttons.

#### FUNCTIONS:

- On / Off
- Operation mode
- Temperature setting
- Fan speed
- Louvres

# 4-WAY CASSETTE

## SMART AIRFLOW

Individual louver control enables airflow to be chosen according to user preferences. The angles of each louver can be set individually in 3 different choices of swing patterns; Standard swing, Dual swing and Cyclic swing.

### STANDARD SWING

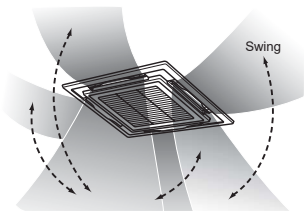

### CYCLIC SWING

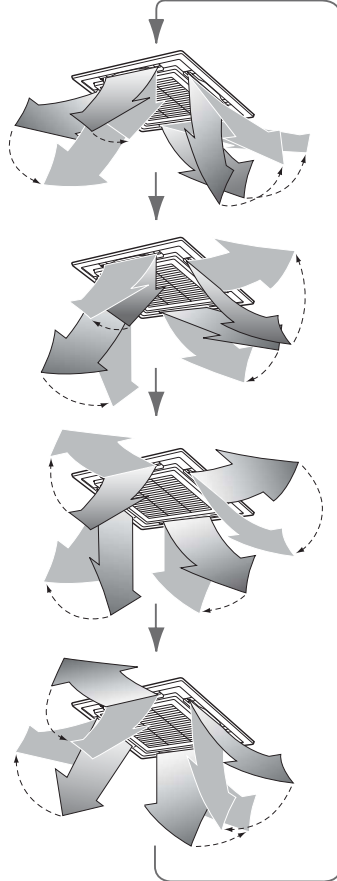

### DUAL SWING

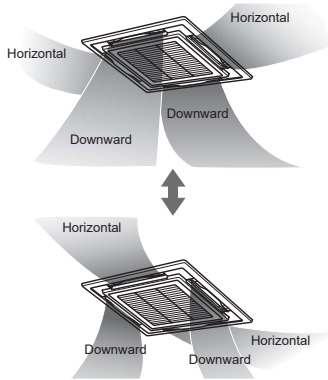

## STANDARD TO HIGH CEILING APPLICATIONS

Toshiba 4-Way Cassettes are designed for standard to high ceiling applications.

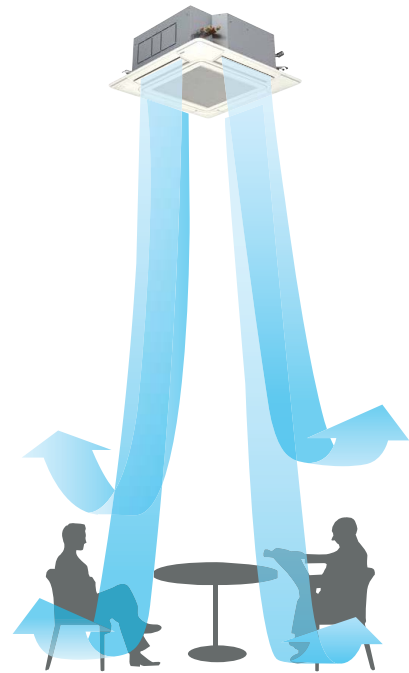

## POWER SAVING

Set limits that restrict power consumption and reduce power bills.

Power consumption is given first priority, and limits maximum power consumption of the unit.

## BUILT-IN CONDENSATE DRAIN PUMP

Equipped with a built-in drain pump with a pressure lift of 850mm, increasing flexibility and installation speed.

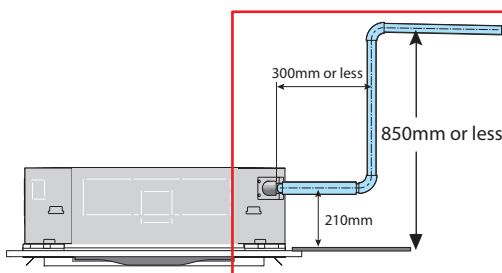

## SELF CLEAN MODE

The unit dries internally by running on FAN operation once normal cycle has ceased, allowing the unit to be kept clean and reducing the built up of allergens, dust and odours.

# 4-WAY CASSETTE SPECIFICATIONS

## DIGITAL INVERTER [DI]

INDOOR UNIT		RAV-GM561UTP-A	RAV-GM801UTP-A	RAV-GM1101UTP-A	RAV-GM1401UTP-A	RAV-GM1601UTP-A	RAV-GM1601UTP-A
OUTDOOR UNIT		RAV-GM561ATP-A	RAV-GM801ATP-A	RAV-GM1101ATP-A	RAV-GM1401ATP-A	RAV-GM1601ATP-A	RAV-GM1601AT8P-A
Cooling Capacity Range	kW	5.0 [1.5 - 5.6]	7.1 [1.5 - 8.0]	10.0 [3.0 - 11.2]	12.5 [3.0 - 14.0]	14.0 [3.0 - 16.0]	14.0 [3.0 - 16.0]
Heating Capacity Range	kW	5.3 [1.5 - 6.3]	8.0 [1.5 - 9.0]	11.2 [3.0 - 13.0]	14.0 [3.0 - 16.0]	16.0 [3.0 - 18.0]	16.0 [3.0 - 18.0]
EER		3.50	3.60	3.50	3.20	3.20	3.20
COP		4.31	3.81	4.00	3.76	3.65	3.65
Maximum Operating Current	A	15.50	17.00	22.80	26.00	29.00	16.10
Dimensions - Indoor [H x W x D]		256 x 840 x 840	256 x 840 x 840	319 x 840 x 840	319 x 840 x 840	319 x 840 x 840	319 x 840 x 840
Dimensions - Outdoor [H x W x D]	mm	550 x 780 x 290	630 x 800 x 300	890 x 900 x 320	890 x 900 x 320	1340 x 900 x 320	1340 x 900 x 320
Dimensions - Panel [H x W x D]		30 x 950 x 950	30 x 950 x 950	30 x 950 x 950	30 x 950 x 950	30 x 950 x 950	30 x 950 x 950
Weight - Indoor / Outdoor / Panel	kg	20 / 40 / 4.2	20 / 47 / 4.2	24 / 64 / 4.2	24 / 68 / 4.2	24 / 97 / 4.2	24 / 96 / 4.2
Airflow [H / M / L]	l/s	291 / 240 / 216	341 / 266 / 225	597 / 416 / 350	638 / 511 / 416	638 / 511 / 416	638 / 511 / 416
Sound Pressure Level Indoor / Outdoor	dB(A)	32 / 48	35 / 51	47 / 55	48 / 57	48 / 57	48 / 57
Operating Range Cooling	°C db	-15 to 46	-15 to 46	-15 to 46	-15 to 46	-15 to 46	-15 to 46
Operating Range Heating	°C wb	-15 to 15	-15 to 15	-15 to 15	-15 to 15	-15 to 24	-15 to 24
Pipe Sizes (Liquid / Gas)	mm	6.35 / 12.70	9.52 / 15.88	9.52 / 15.88	9.52 / 15.88	9.52 / 15.88	9.52 / 15.88
Maximum Pipe Length / Lift		30 / 30	50 / 30	50 / 30	50 / 30	50 / 30	50 / 30
Maximum Pre-charged Length	m	20	20	30	30	30	30
Power Supply	Ph / V / Hz	1ph / 220-240V / 50Hz	1ph / 220-240V / 50Hz	1ph / 220-240V / 50Hz	1ph / 220-240V / 50Hz	1ph / 220-240V / 50Hz	3ph / 380-415V / 50Hz

## SUPER DIGITAL INVERTER [SDI] - SINGLE PHASE

INDOOR UNIT		RAV-GM561UTP-A	RAV-GM801UTP-A	RAV-GM1101UTP-A	RAV-GM1401UTP-A	RAV-GM1601UTP-A
OUTDOOR UNIT		RAV-GP561ATP-A	RAV-GP801ATP-A	RAV-GP1101ATP-A	RAV-GP1401ATP-A	RAV-GP1601ATP-A
Cooling Capacity Range	kW	5.0 [1.2 - 6.0]	7.1 [1.9 - 8.0]	10.0 [2.6 - 12.0]	12.5 [2.6 - 14.0]	14.0 [2.6 - 16.0]
Heating Capacity Range	kW	5.6 [0.9 - 8.1]	8.0 [1.5 - 11.3]	11.2 [2.4 - 13.0]	14.0 [2.4 - 18.0]	16.0 [2.4 - 19.0]
EER		4.10	4.00	4.00	3.65	3.23
COP		4.63	4.20	4.65	4.11	3.74
Maximum Operating Current	A	13.10	15.80	29.00	29.00	29.00
Dimensions - Indoor [H x W x D]		256 x 840 x 840	256 x 840 x 840	319 x 840 x 840	319 x 840 x 840	319 x 840 x 840
Dimensions - Outdoor [H x W x D]	mm	630 x 800 x 300	890 x 900 x 320	1340 x 900 x 320	1340 x 900 x 320	1340 x 900 x 320
Dimensions - Panel [H x W x D]		30 x 950 x 950	30 x 950 x 950	30 x 950 x 950	30 x 950 x 950	30 x 950 x 950
Weight - Indoor / Outdoor / Panel	kg	20 / 43 / 4.2	20 / 67 / 4.2	24 / 102 / 4.2	24 / 102 / 4.2	24 / 102 / 4.2
Airflow [H / M / L]	l/s	291 / 240 / 216	341 / 266 / 225	597 / 416 / 350	638 / 511 / 416	638 / 511 / 416
Sound Pressure Level Indoor / Outdoor	dB(A)	32 / 48	35 / 52	47 / 51	48 / 53	48 / 58
Operating Range Cooling	°C db	-15 to 52	-15 to 52	-15 to 52	-15 to 52	-15 to 52
Operating Range Heating		-20 to 24	-20 to 24	-20 to 24	-20 to 24	-20 to 24
Pipe Sizes (Liquid / Gas)	mm	6.35 / 12.70	9.52 / 15.88	9.52 / 15.88	9.52 / 15.88	9.52 / 15.88
Maximum Pipe Length / Lift		50 / 30	50 / 30	75 / 30	75 / 30	75 / 30
Maximum Pre-charged Length	m	20	30	30	30	30
Power Supply	Ph / V / Hz	1ph / 220-240V / 50Hz	1ph / 220-240V / 50Hz	1ph / 220-240V / 50Hz	1ph / 220-240V / 50Hz	1ph / 220-240V / 50Hz

## SUPER DIGITAL INVERTER [SDI] - THREE PHASE

INDOOR UNIT		RAV-GM1101UTP-A	RAV-GM1401UTP-A	RAV-GM1601UTP-A
OUTDOOR UNIT		RAV-GP1101AT8P-A	RAV-GP1401AT8P-A	RAV-GP1601AT8P-A
Cooling Capacity Range	kW	10.0 [2.6 - 12.0]	12.5 [2.6 - 14.0]	14.0 [2.6 - 16.0]
Heating Capacity Range	kW	11.2 [2.4 - 13.0]	14.0 [2.4 - 18.0]	16.0 [2.4 - 19.0]
EER		4.31	3.65	3.23
COP		4.65	4.11	3.72
Maximum Operating Current	A	16.50	16.50	16.50
Dimensions - Indoor [H x W x D]		256 x 840 x 840	256 x 840 x 840	319 x 840 x 840
Dimensions - Outdoor [H x W x D]	mm	1340 x 900 x 320	1340 x 900 x 320	1340 x 900 x 320
Dimensions - Panel [H x W x D]		30 x 950 x 950	30 x 950 x 950	30 x 950 x 950
Weight - Indoor / Outdoor / Panel	kg	24 / 100 / 4.2	24 / 100 / 4.2	24 / 100 / 4.2
Airflow [H / M / L]	l/s	291 / 240 / 216	341 / 266 / 225	597 / 416 / 350
Sound Pressure Level Indoor / Outdoor	dB(A)	32 / 51	35 / 53	47 / 58
Operating Range Cooling	°C db	-15 to 52	-15 to 52	-15 to 52
Operating Range Heating		-20 to 24	-20 to 24	-20 to 24
Pipe Sizes (Liquid / Gas)	mm	9.52 / 15.88	9.52 / 15.88	9.52 / 15.88
Maximum Pipe Length / Lift		75 / 30	75 / 30	75 / 30
Maximum Pre-charged Length	m	30	30	30
Power Supply	Ph / V / Hz	3ph / 380-415V / 50Hz	3ph / 380-415V / 50Hz	3ph / 380-415V / 50Hz

Refer to the Engineering Databook for details on these conditions and requirements.

Rate conditions: Cooling: Indoor 27 °C Dry Bulb / 19 °C Wet Bulb, Outdoor 35 °C Dry Bulb.  
Heating: Indoor 20 °C Dry Bulb, Outdoor 7 °C Dry Bulb / 6 °C Wet Bulb.  
Base on equivalent piping length of 7.5m and piping height difference of 0m.

# HIGH WALLS

## SELF CLEANING FUNCTION

Toshiba's self-cleaning function is designed to reduce the humidity that causes mold to form inside an air-conditioning units. 20 minutes of fan operation after shut down dries the moist air and helps reduce mold formation on the heat exchanger coils.

### Normal Operation

Moisture stays trapped inside



### Self-cleaning Function

20 minutes of fan operation after shut down dries the moist air and helps reduce mold formation on heat exchanger coils.



## OPTIMUM AIR DISTRIBUTION

70° directional Auto-swing louver mode allows optimum air distribution throughout the room. Total comfort is granted, thanks also to Automatic air volume control and Automatic cooling/heating.

Cooling mode 10°~45°

Heating mode 10°~70°

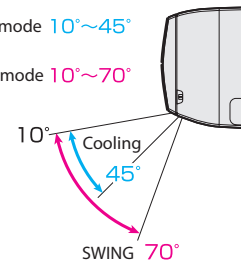

## ON AND OFF TIMER

Schedule the unit to turn ON / OFF at designated times using the wireless controller.

Start the air conditioner when you enter your office and stop it when its time to head home, this setting can be applied for the same time, every day.

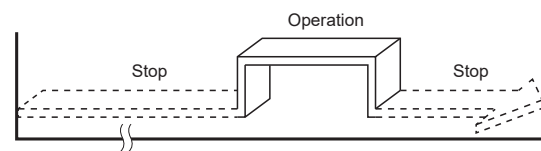
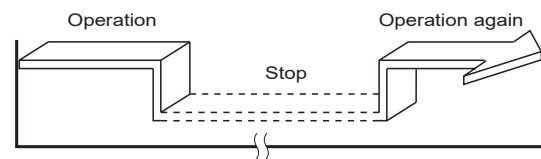

## HI POWER MODE

The HI POWER mode automatically controls room temperature, airflow and operation mode so that, the room is quickly cooled in summer and warmed in winter.

## ENJOY COMFORT IN SILENCE

Get quiet system operation by selecting the "QUIET" mode to automatically set the fan speed to the lowest speed.

# HIGH WALLS SPECIFICATIONS



## DIGITAL INVERTER [DI]

INDOOR UNIT		RAV-GM301KRTP-A	RAV-GM401KRTP-A	RAV-GM561KRTP-A	RAV-GM801KRTP-A
OUTDOOR UNIT		RAV-GM301ATP-A	RAV-GM401ATP-A	RAV-GM561ATP-A	RAV-GM801ATP-A
Cooling Capacity Range	kW	2.5 [0.9 - 3.0]	3.6 [0.9 - 4.0]	5.0 [1.5 - 5.6]	7.1 [1.5 - 8.0]
Heating Capacity Range	kW	3.4 [0.8 - 4.5]	4.0 [0.8 - 5.0]	5.3 [1.5 - 6.3]	8.0 [1.5 - 9.0]
EER		4.24	3.71	3.31	3.35
COP		4.00	4.00	3.90	3.40
Maximum Operating Current	A	7.90	9.20	15.50	17.00
Dimensions - Indoor [H x W x D]	mm	293 x 798 x 230	293 x 798 x 230	320 x 1050 x 250	320 x 1050 x 250
Dimensions - Outdoor [H x W x D]	mm	550 x 780 x 290	550 x 780 x 290	550 x 780 x 290	630 x 800 x 300
Weight - Indoor / Outdoor	kg	10 / 29	10 / 34	14 / 40	14 / 47
Airflow [H / M / L]	l/s	186 / 150 / 125	194 / 161 / 125	266 / 230 / 188	288 / 252 / 188
Sound Pressure Level Indoor / Outdoor	dB(A)	40 / 47	41 / 50	42 / 48	45 / 51
Operating Range Cooling	°C db	-15 to 46	-15 to 46	-15 to 46	-15 to 46
Operating Range Heating	°C db	-15 to 15	-15 to 15	-15 to 15	-15 to 15
Pipe Sizes (Liquid / Gas)	mm	6.35 / 9.52	6.35 / 12.70	6.35 / 12.70	9.52 / 15.88
Maximum Pipe Length / Lift	m	20 / 10	20 / 10	30 / 30	50 / 30
Maximum Pre-charged Length		15	15	20	20
Power Supply	Ph / V / Hz	1ph / 220-240V / 50Hz	1ph / 220-240V / 50Hz	1ph / 220-240V / 50Hz	1ph / 220-240V / 50Hz

## SUPER DIGITAL INVERTER [SDI]

INDOOR UNIT		RAV-GM561KRTP-A	RAV-GM801KRTP-A
OUTDOOR UNIT		RAV-GP561ATP-A	RAV-GP801ATP-A
Cooling Capacity Range	kW	5.0 [1.2 - 6.0]	7.1 [1.9 - 8.0]
Heating Capacity Range	kW	5.6 [0.9 - 7.4]	8.0 [1.5 - 10.6]
EER		3.97	3.90
COP		4.00	3.60
Maximum Operating Current	A	13.10	15.80
Dimensions - Indoor [H x W x D]	mm	320 x 1050 x 250	320 x 1050 x 250
Dimensions - Outdoor [H x W x D]	mm	630 x 800 x 300	890 x 900 x 320
Weight - Indoor / Outdoor	kg	14 / 43	14 / 67
Airflow [H / M / L]	l/s	266 / 230 / 188	288 / 252 / 188
Sound Pressure Level Indoor / Outdoor	dB(A)	42 / 48	45 / 52
Operating Range Cooling	°C db	-15 to 52	-15 to 52
Operating Range Heating	°C db	-20 to 24	-20 to 24
Pipe Sizes (Liquid / Gas)	mm	6.35 / 12.70	9.52 / 15.88
Maximum Pipe Length / Lift	m	50 / 30	50 / 30
Maximum Pre-charged Length		20	30
Power Supply	Ph / V / Hz	1ph / 220-240V / 50Hz	1ph / 220-240V / 50Hz

Refer to the Engineering Databook for details on these conditions and requirements.

Rate conditions: Cooling: Indoor 27 °C Dry Bulb / 19 °C Wet Bulb, Outdoor 35 °C Dry Bulb.  
Heating: Indoor 20 °C Dry Bulb, Outdoor 7 °C Dry Bulb / 6 °C Wet Bulb.  
Base on equivalent piping length of 7.5m and piping height difference of 0m.

# CONTROLS OPTIONS



BACKLIT WIRED CONTROLLER

RBC-AMS55E-ES / RBC-AMSU51-ES



COMPACT WIRED CONTROLLER

RBC-ASC11E / RBC-ASCU11-E



STANDARD WIRED CONTROLLER

RBC-AMT32E / RBC-AMS41E

# MID-STATIC DUCTED

## SEAMLESS DESIGN & INSTALLATION FLEXIBILITY

Toshiba ducted systems allow for a range of diffuser designs to best suit any decor.

Versatile and easy installation also made possible with the capability of adjusting the distance between the air intake and the air outlet vents to create the optimal airflow configuration.



Polygon Rooms



Polygon Rooms



Narrow Rooms



Rooms with fixtures and  
obstacles

## BUILT-IN DRAIN PUMP

The flexible piping layout is made possible by the built-in drain-pump kit that raises the drain piping up to 850mm from the drain port.

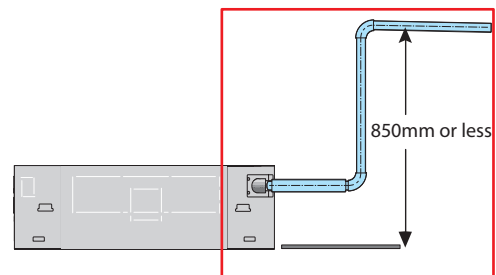

## SPACE SAVING DESIGN

With a height of 275mm, the Toshiba mid-static ducted can be installed in almost any application including homes, apartments or commercial buildings.

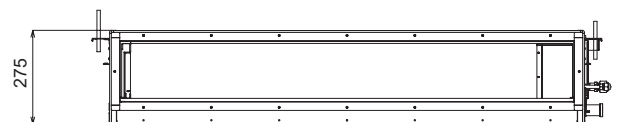

## WEEKLY TIMER

A hassle-free, intuitive management system via the wired controller. A fully programmable 7-day timer offering the ability to completely eliminate the need to manually control the air conditioner.

The weekly timer function enables users to preset the unit to automatically turn on and off or change temperature to suit user's weekly schedule.

The 7-day timer function allows the user to set up to eight ON/OFF and temperature settings for each day of the week.

\* Feature available on model: RBC-AMS55E-ES



# MID-STATIC DUCTED SPECIFICATIONS

## DIGITAL INVERTER [DI]

INDOOR UNIT		RAV-GM561BTP-A	RAV-GM801BTP-A	RAV-GM1101BTP-A	RAV-GM1401BTP-A	RAV-GM1601BTP-A	RAV-GM1601BTP-A
OUTDOOR UNIT		RAV-GM561ATP-A	RAV-GM801ATP-A	RAV-GM1101ATP-A	RAV-GM1401ATP-A	RAV-GM1601ATP-A	RAV-GM1601AT8P-A
Cooling Capacity Range	kW	5.0 [1.5 - 5.6]	7.1 [1.5 - 8.0]	10.0 [3.0 - 11.2]	12.5 [3.0 - 14.0]	14.0 [3.0 - 16.0]	14.0 [3.0 - 16.0]
Heating Capacity Range	kW	5.3 [1.5 - 6.3]	8.0 [1.5 - 9.0]	11.2 [3.0 - 13.0]	14.0 [3.0 - 16.0]	16.0 [3.0 - 18.0]	16.0 [3.0 - 18.0]
EER		3.31	3.60	3.36	3.10	3.20	3.20
COP		3.71	4.00	4.00	3.60	3.50	3.50
Maximum Operating Current	A	15.50	17.00	22.80	26.00	29.00	16.10
Dimensions - Indoor [H x W x D]	mm	275 x 700 x 750	275 x 1000 x 750	275 x 1400 x 750	275 x 1400 x 750	275 x 1400 x 750	275 x 1400 x 750
Dimensions - Outdoor [H x W x D]	mm	550 x 780 x 290	630 x 800 x 300	890 x 900 x 320	890 x 900 x 320	1340 x 900 x 320	1340 x 900 x 320
Weight - Indoor / Outdoor	kg	23 / 40	31 / 47	41 / 64	41 / 68	41 / 97	41 / 96
Airflow [H / M / L]	l/s	280 / 250 / 200	472 / 388 / 277	583 / 458 / 361	611 / 513 / 416	652 / 555 / 416	652 / 555 / 416
Sound Pressure Level Indoor / Outdoor	dB(A)	34 / 48	40 / 51	40 / 55	41 / 57	42 / 57	42 / 57
Static Pressure	Pa	30 - 180	30 - 180	50 - 200	50 - 200	50 - 200	50 - 200
Operating Range Cooling	°C db	-15 to 46	-15 to 46	-15 to 46	-15 to 46	-15 to 46	-15 to 46
Operating Range Heating	°C wb	-15 to 15	-15 to 15	-15 to 15	-15 to 15	-15 to 24	-15 to 24
Pipe Sizes (Liquid / Gas)	mm	6.35 / 12.70	9.52 / 15.88	9.52 / 15.88	9.52 / 15.88	9.52 / 15.88	9.52 / 15.88
Maximum Pipe Length / Lift	m	30 / 30	50 / 30	50 / 30	50 / 30	50 / 30	50 / 30
Maximum Pre-charged Length	m	20	20	30	30	30	30
Power Supply	Ph / V / Hz	1ph / 220-240V / 50Hz	1ph / 220-240V / 50Hz	1ph / 220-240V / 50Hz	1ph / 220-240V / 50Hz	1ph / 220-240V / 50Hz	3ph / 380-415V / 50Hz

## SUPER DIGITAL INVERTER [SDI] - SINGLE PHASE

INDOOR UNIT		RAV-GM561BTP-A	RAV-GM801BTP-A	RAV-GM1101BTP-A	RAV-GM1401BTP-A	RAV-GM1601BTP-A
OUTDOOR UNIT		RAV-GP561ATP-A	RAV-GP801ATP-A	RAV-GP1101ATP-A	RAV-GP1401ATP-A	RAV-GP1601ATP-A
Cooling Capacity Range	kW	5.0 [1.2 - 6.0]	7.1 [1.9 - 8.0]	10.0 [2.6 - 12.0]	12.5 [2.6 - 14.0]	14.0 [2.6 - 16.0]
Heating Capacity Range	kW	5.6 [0.9 - 8.1]	8.0 [1.5 - 11.3]	11.2 [2.4 - 13.0]	14.0 [2.4 - 18.0]	16.0 [2.4 - 19.0]
EER		3.50	3.70	4.10	3.45	3.23
COP		4.00	4.20	4.30	3.85	3.56
Maximum Operating Current	A	13.10	15.80	29.00	29.00	29.00
Dimensions - Indoor [H x W x D]	mm	275 x 700 x 750	275 x 1000 x 750	275 x 1400 x 750	275 x 1400 x 750	275 x 1400 x 750
Dimensions - Outdoor [H x W x D]	mm	630 x 800 x 300	890 x 900 x 320	1340 x 900 x 320	1340 x 900 x 320	1340 x 900 x 320
Weight - Indoor / Outdoor	kg	23 / 43	31 / 62	41 / 102	41 / 102	41 / 102
Airflow [H / M / L]	l/s	280 / 250 / 200	472 / 388 / 277	583 / 458 / 361	611 / 513 / 416	652 / 555 / 416
Sound Pressure Level Indoor / Outdoor	dB(A)	38 / 48	40 / 52	40 / 51	41 / 53	42 / 58
Static Pressure	Pa	30 - 180	30 - 180	50 - 200	50 - 200	50 - 200
Operating Range Cooling	°C db	-15 to 52	-15 to 52	-15 to 52	-15 to 52	-15 to 52
Operating Range Heating	°C wb	-20 to 24	-20 to 24	-20 to 24	-20 to 24	-20 to 24
Pipe Sizes (Liquid / Gas)	mm	6.35 / 12.70	9.52 / 15.88	9.52 / 15.88	9.52 / 15.88	9.52 / 15.88
Maximum Pipe Length / Lift	m	50 / 30	50 / 30	75 / 30	75 / 30	75 / 30
Maximum Pre-charged Length	m	20	30	30	30	30
Power Supply	Ph / V / Hz	1ph / 220-240V / 50Hz	1ph / 220-240V / 50Hz	1ph / 220-240V / 50Hz	1ph / 220-240V / 50Hz	1ph / 220-240V / 50Hz

## SUPER DIGITAL INVERTER [SDI] - THREE PHASE

INDOOR UNIT		RAV-GM1101BTP-A	RAV-GM1401BTP-A	RAV-GM1601BTP-A
OUTDOOR UNIT		RAV-GP1101AT8P-A	RAV-GP1401AT8P-A	RAV-GP1601AT8P-A
Cooling Capacity Range	kW	10.0 [2.6 - 12.0]	12.5 [2.6 - 14.0]	14.0 [2.6 - 16.0]
Heating Capacity Range	kW	11.2 [2.4 - 13.0]	14.0 [2.4 - 18.0]	16.0 [2.4 - 19.0]
EER		4.10	3.45	3.23
COP		4.30	3.85	3.56
Maximum Operating Current	A	16.50	16.50	16.50
Dimensions - Indoor [H x W x D]	mm	275 x 1400 x 750	275 x 1400 x 750	275 x 1400 x 750
Dimensions - Outdoor [H x W x D]	mm	1340 x 900 x 320	1340 x 900 x 320	1340 x 900 x 320
Weight - Indoor / Outdoor	kg	41 / 100	41 / 100	41 / 100
Airflow [H / M / L]	l/s	583 / 458 / 361	611 / 513 / 416	652 / 555 / 416
Sound Pressure Level Indoor / Outdoor	dB(A)	40 / 51	41 / 53	42 / 58
Static Pressure	Pa	50 - 200	50 - 200	50 - 200
Operating Range Cooling	°C db	-15 to 52	-15 to 52	-15 to 52
Operating Range Heating	°C wb	-20 to 24	-20 to 24	-20 to 24
Pipe Sizes (Liquid / Gas)	mm	9.52 / 15.88	9.52 / 15.88	9.52 / 15.88
Maximum Pipe Length / Lift	m	75 / 30	75 / 30	75 / 30
Maximum Pre-charged Length	m	30	30	30
Power Supply	Ph / V / Hz	3ph / 380-415V / 50Hz	3ph / 380-415V / 50Hz	3ph / 380-415V / 50Hz

## SPIGOTS

Spigot for 566BT



Spigot for 806BT



Spigot for 1106 / 1406 / 1601



Refer to the Engineering Databook for details on these conditions and requirements.

Rate conditions: Cooling: Indoor 27 °C Dry Bulb / 19 °C Wet Bulb, Outdoor 35 °C Dry Bulb.  
Heating: Indoor 20 °C Dry Bulb, Outdoor 7 °C Dry Bulb / 6 °C Wet Bulb.  
Base on equivalent piping length of 7.5m and piping height difference of 0m.

Spigots are sold separately for the mid-static ducted range

# HIGH-STATIC DUCTED

## HIGH STATIC PRESSURE & AIRFLOW

Toshiba high static ducted systems provide a wide range of static pressure, allowing airflow to be directed to different areas of the home or office with ease.

With static pressure ranging from 50 to 270Pa and increased variation to airflow, ensures operation that suits most room layouts, making it an ideal system for cooling & heating multiple spaces.

\* Fan curve illustration of model RAV-GM1401DTP-A

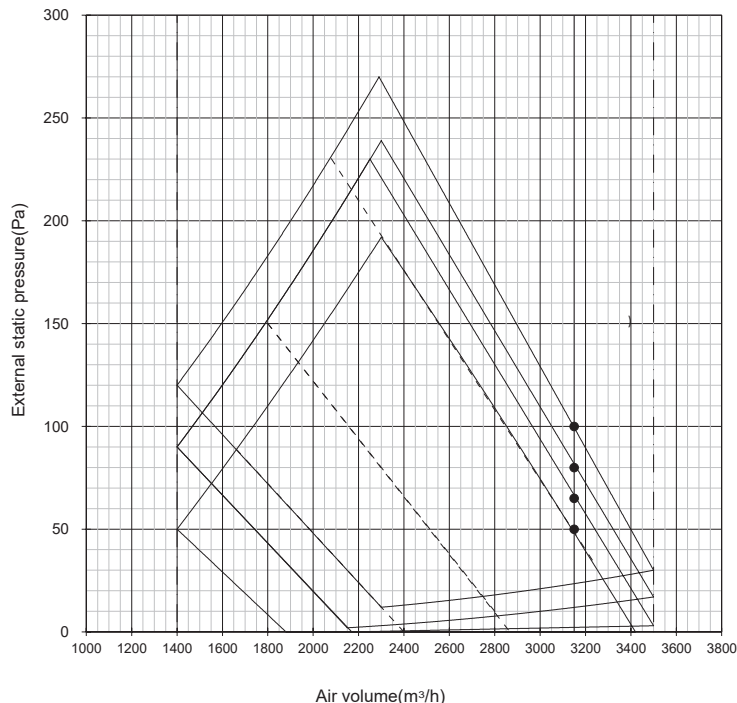

## SEAMLESS DESIGN & INSTALLATION FLEXIBILITY

Toshiba high static ducted systems allow for a range of diffuser designs to best suit any decor.

Versatile and easy installation also made possible with the capability of adjusting the distance between the air intake and the air outlet vents to create the optimal airflow configuration.

## BUILT-IN DRAIN PUMP

The flexible piping layout is made possible by the built-in drain-pump kit that raises the drain piping up to 850mm from the drain port.

\* Drain pump optional on the 20.0kW and 24.0kW indoor units

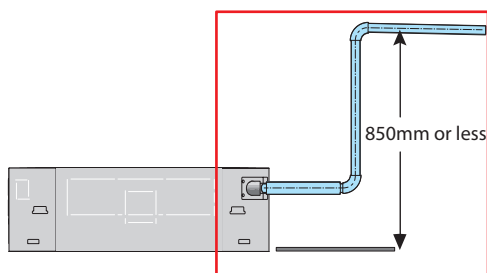

## ZONING WITH T-ZONE

For times when you only want to condition certain spaces, zoning can be the answer. Whether you are looking at installing a new Toshiba ducted system or have an existing system retrofitted, zoning can save energy, and reduce wear and tear of your system.

T-Zone gives you total temperature control of each space individually. With up to 14 zones capability, every space can be at the perfect temperature at all times.



# HIGH-STATIC DUCTED SPECIFICATIONS

## DIGITAL INVERTER [DI]

INDOOR UNIT		RAV-GM561DTP-A	RAV-GM801DTP-A	RAV-GM1101DTP-A	RAV-GM1401DTP-A	RAV-GM1601DTP-A	RAV-GM1601DTP-A
OUTDOOR UNIT		RAV-GM561ATP-A	RAV-GM801ATP-A	RAV-GM1101ATP-A	RAV-GM1401ATP-A	RAV-GM1601ATP-A	RAV-GM1601AT8P-A
Cooling Capacity Range	kW	5.0 [1.5 - 5.6]	7.1 [1.5 - 8.0]	10.0 [3.0 - 11.2]	12.5 [3.0 - 14.0]	14.0 [3.0 - 16.0]	14.0 [3.0 - 16.0]
Heating Capacity Range	kW	5.3 [1.5 - 6.3]	8.0 [1.5 - 9.0]	11.2 [3.0 - 13.0]	14.0 [3.0 - 16.0]	16.0 [3.0 - 18.0]	16.0 [3.0 - 18.0]
EER		3.36	3.90	3.30	3.20	3.20	3.20
COP		4.31	4.00	4.00	3.61	3.86	3.86
Maximum Operating Current	A	15.50	17.00	22.80	26.00	29.00	16.10
Dimensions - Indoor [H x W x D]	mm	298 x 1000 x 750	298 x 1000 x 750	298 x 1400 x 750	298 x 1400 x 750	298 x 1400 x 750	298 x 1400 x 750
Dimensions - Outdoor [H x W x D]	mm	550 x 780 x 290	630 x 800 x 300	890 x 900 x 320	890 x 900 x 320	1340 x 900 x 320	1340 x 900 x 320
Weight - Indoor / Outdoor	kg	34 / 40	34 / 47	42 / 64	42 / 68	42 / 97	42 / 96
Airflow [H / M / L]	l/s	388 / 333 / 277	583 / 430 / 361	805 / 694 / 466	875 / 716 / 569	972 / 902 / 597	972 / 902 / 597
Sound Pressure Level Indoor / Outdoor	dB(A)	36 / 48	41 / 51	48 / 55	49 / 57	50 / 57	50 / 57
Static Pressure	Pa	50 - 150	50 - 150	50 - 270	50 - 270	50 - 270	50 - 270
Operating Range Cooling	°C db	-15 to 46	-15 to 46	-15 to 46	-15 to 46	-15 to 46	-15 to 46
Operating Range Heating	°C wb	-15 to 15	-15 to 15	-15 to 15	-15 to 15	-15 to 24	-15 to 24
Pipe Sizes (Liquid / Gas)	mm	6.35 / 12.70	9.52 / 15.88	9.52 / 15.88	9.52 / 15.88	9.52 / 15.88	9.52 / 15.88
Maximum Pipe Length / Lift	m	30 / 30	50 / 30	50 / 30	50 / 30	50 / 30	50 / 30
Maximum Pre-charged Length	m	20	20	30	30	30	30
Power Supply	Ph / V / Hz	1ph / 220-240V / 50Hz	1ph / 220-240V / 50Hz	1ph / 220-240V / 50Hz	1ph / 220-240V / 50Hz	1ph / 220-240V / 50Hz	3ph / 380-415V / 50Hz

## DIGITAL INVERTER [DI] - Continued

INDOOR UNIT		RAV-RM2241DTP-E2	RAV-RM2801DTP-E2
OUTDOOR UNIT		RAV-GM2241AT8-A	RAV-GM2801AT8-A
Cooling Capacity Range	kW	20.0 [4.6 - 22.4]	24.0 [4.6 - 27.0]
Heating Capacity Range	kW	22.4 [4.6 - 25.0]	27.0 [4.6 - 31.5]
EER		3.23	3.01
COP		3.92	3.59
Maximum Operating Current	A	18.00	23.00
Dimensions - Indoor [H x W x D]	mm	448 x 1400 x 900	448 x 1400 x 900
Dimensions - Outdoor [H x W x D]	mm	1550 x 1010 x 370	1550 x 1010 x 370
Weight - Indoor / Outdoor	kg	97 / 142	97 / 142
Airflow [H / M / L]	l/s	1055 / 888 / 694	1333 / 1166 / 972
Sound Pressure Level Indoor / Outdoor	dB(A)	44 / 60	46 / 63
Static Pressure	Pa	50 - 250	50 - 250
Operating Range Cooling	°C db	-15 to 46	-15 to 46
Operating Range Heating	°C db	-27 to 15	-27 to 15
Pipe Sizes (Liquid / Gas)	mm	12.70 / 28.60	12.70 / 28.60
Maximum Pipe Length / Lift	m	100 / 30	100 / 30
Maximum Pre-charged Length	m	30	30
Power Supply	Ph / V / Hz	3ph / 380-415V / 50Hz	3ph / 380-415V / 50Hz

## SUPER DIGITAL INVERTER [SDI]

INDOOR UNIT		RAV-GM561DTP-A
OUTDOOR UNIT		RAV-GP561ATP-A
Cooling Capacity Range	kW	5.0 [1.2 - 6.0]
Heating Capacity Range	kW	5.6 [0.9 - 7.4]
EER		3.70
COP		4.60
Maximum Operating Current	A	13.10
Dimensions - Indoor [H x W x D]	mm	298 x 1000 x 750
Dimensions - Outdoor [H x W x D]	mm	630 x 800 x 300
Weight - Indoor / Outdoor	kg	34 / 43
Airflow [H / M / L]	l/s	388 / 333 / 277
Sound Pressure Level Indoor / Outdoor	dB(A)	36 / 48
Static Pressure	Pa	50 - 150
Operating Range Cooling	°C db	-15 to 52
Operating Range Heating	°C db	-20 to 24
Pipe Sizes (Liquid / Gas)	mm	6.35 / 12.70
Maximum Pipe Length / Lift	m	50 / 30
Maximum Pre-charged Length	m	20
Power Supply	Ph / V / Hz	1ph / 220-240V / 50Hz

## SUPER DIGITAL INVERTER [SDI] - Continued

INDOOR UNIT		RAV-GM801DTP-A	RAV-GM1101DTP-A	RAV-GM1401DTP-A	RAV-GM1601DTP-A	RAV-GM1101DTP-A	RAV-GM1401DTP-A	RAV-GM1601DTP-A
OUTDOOR UNIT		RAV-GP801ATP-A	RAV-GP1101ATP-A	RAV-GP1401ATP-A	RAV-GP1601ATP-A	RAV-GP1101AT8P-A	RAV-GP1401AT8P-A	RAV-GP1601AT8P-A
Cooling Capacity Range	kW	7.1 [1.9 - 8.0]	10.0 [2.6 - 12.0]	12.5 [2.6 - 14.0]	14.0 [2.6 - 16.0]	10.0 [2.6 - 12.0]	12.5 [2.6 - 14.0]	14.0 [2.6 - 16.0]
Heating Capacity Range	kW	8.0 [1.5 - 11.3]	11.2 [2.4 - 13.0]	14.0 [2.4 - 18.0]	16.0 [2.4 - 19.0]	11.2 [2.4 - 13.0]	14.0 [2.4 - 18.0]	16.0 [2.4 - 19.0]
EER		4.00	3.75	3.43	3.31	3.75	3.43	3.31
COP		4.35	4.40	4.15	3.90	4.40	4.15	3.90
Maximum Operating Current	A	15.80	29.00	29.00	29.00	16.50	16.50	16.50
Dimensions - In [H x W x D]	mm	298 x 1000 x 750	298 x 1400 x 750	298 x 1400 x 750	298 x 1400 x 750	298 x 1400 x 750	298 x 1400 x 750	298 x 1400 x 750
Dimensions - Out [H x W x D]	mm	890 x 900 x 320	1340 x 900 x 320	1340 x 900 x 320	1340 x 900 x 320	1340 x 900 x 320	1340 x 900 x 320	1340 x 900 x 320
Weight - Indoor / Outdoor	kg	34 / 62	42 / 102	42 / 102	42 / 102	42 / 100	42 / 100	42 / 100
Airflow [H / M / L]	l/s	583 / 430 / 361	805 / 694 / 466	875 / 716 / 569	972 / 902 / 597	805 / 694 / 466	875 / 716 / 569	972 / 902 / 597
Sound Pressure Level [in/out]	dB(A)	41 / 52	48 / 51	49 / 53	50 / 58	48 / 51	49 / 53	50 / 58
Static Pressure	Pa	50 - 150	50 - 270	50 - 270	50 - 270	50 - 270	50 - 270	50 - 270
Operating Range Cooling	°C db	-15 to 52	-15 to 52	-15 to 52	-15 to 52	-15 to 52	-15 to 52	-15 to 52
Operating Range Heating	°C db	-20 to 24	-20 to 24	-20 to 24	-20 to 24	-20 to 24	-20 to 24	-20 to 24
Pipe Sizes (Liquid / Gas)	mm	9.52 / 15.88	9.52 / 15.88	9.52 / 15.88	9.52 / 15.88	9.52 / 15.88	9.52 / 15.88	9.52 / 15.88
Maximum Pipe Length / Lift	m	50 / 30	75 / 30	75 / 30	75 / 30	75 / 30	75 / 30	75 / 30
Maximum Pre-charged Length	m	30	30	30	30	30	30	30
Power Supply	Ph / V / Hz		1ph / 220-240V / 50Hz				3ph / 380-415V / 50Hz	

Refer to the Engineering Databook for details on these conditions and requirements.

Rate conditions: Cooling: Indoor 27 °C Dry Bulb / 19 °C Wet Bulb, Outdoor 35 °C Dry Bulb.  
Heating: Indoor 20 °C Dry Bulb, Outdoor 7 °C Dry Bulb / 6 °C Wet Bulb.  
Base on equivalent piping length of 7.5m and piping height difference of 0m.

# UNDER CEILING

## SELF CLEANING FUNCTION

Toshiba's self-cleaning function is designed to reduce the humidity that causes mold to form inside an air-conditioning units. 20 minutes of fan operation after shut down dries the moist air and helps reduce mold formation on heat exchanger coils.

## SMOOTH CURVES

Toshiba's new Under Ceiling units have adopted a more rounded and sleek chassis design to compliment any decor,

## OPTIONAL DRAIN PUMP

Reduce mould formation with the optional drain pump kit with built-in glass that aids in mould formation over time.

## AIR CONTROL

The airflow angle is automatically set to the most suitable setting according to your cooling or heating needs, and an automatic swing mode enables airflow to reach all areas of the room to create a comfortable ambience.

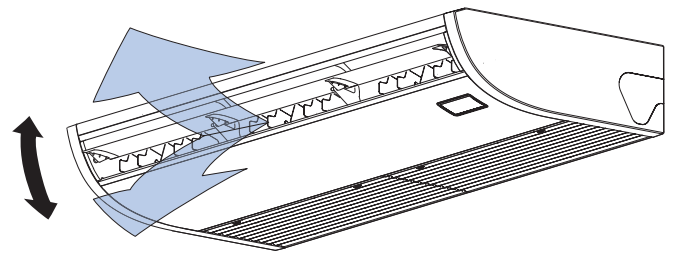

## RE-DESIGNED WIDER FLAP

The new air outlet has been re-designed allowing for high noise reduction and increased air volume circulation compared to the previous series.

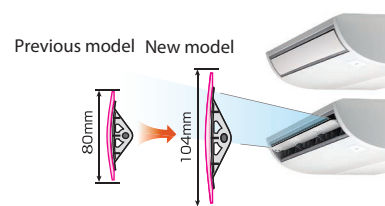

## COMFORTABLE AMBIENCE

With the implementation of the improved fan design, the Toshiba under ceiling unit now has increased air volume circulation and reduced noise levels compared to the previous models.

Air throw can now extend up to 4.3m, creating comfortable spaces with reduced cold & hot spots.

# UNDER CEILING SPECIFICATIONS

## DIGITAL INVERTER [DI]

INDOOR UNIT		RAV-GM561CTP-A	RAV-GM801CTP-A	RAV-GM1101CTP-A	RAV-GM1401CTP-A	RAV-GM1601CTP-A	RAV-GM1601CTP-A
OUTDOOR UNIT		RAV-GM561ATP-A	RAV-GM801ATP-A	RAV-GM1101ATP-A	RAV-GM1401ATP-A	RAV-GM1601ATP-A	RAV-GM1601AT8P-A
Cooling Capacity Range	kW	5.0 [1.5 - 5.6]	7.1 [1.5 - 8.0]	10.0 [3.0 - 11.2]	12.5 [3.0 - 14.0]	14.0 [3.0 - 16.0]	14.0 [3.0 - 16.0]
Heating Capacity Range	kW	5.3 [1.5 - 6.3]	8.0 [1.5 - 9.0]	11.2 [3.0 - 13.0]	14.0 [3.0 - 16.0]	16.0 [3.0 - 18.0]	16.0 [3.0 - 18.0]
EER		3.31	3.60	3.36	3.10	3.10	3.10
COP		3.90	4.00	4.00	3.74	3.65	3.65
Maximum Operating Current	A	15.50	17.00	22.80	26.00	29.00	16.10
Dimensions - Indoor [H x W x D]	mm	235 x 950 x 690	235 x 1270 x 690	235 x 1586 x 690	235 x 1586 x 690	235 x 1586 x 690	235 x 1586 x 690
Dimensions - Outdoor [H x W x D]	mm	550 x 780 x 290	630 x 800 x 300	890 x 900 x 320	890 x 900 x 320	1340 x 900 x 320	1340 x 900 x 320
Weight - Indoor / Outdoor	kg	23 / 47	29 / 47	37 / 64	37 / 68	37 / 97	37 / 96
Airflow [H / M / L]	l/s	250 / 200 / 150	391 / 277 / 208	516 / 375 / 283	566 / 425 / 333	566 / 458 / 350	566 / 458 / 350
Sound Pressure Level Indoor / Outdoor	dB(A)	37 / 48	41 / 51	44 / 55	46 / 57	46 / 57	46 / 57
Operating Range Cooling	°C db	-15 to 46	-15 to 46	-15 to 46	-15 to 46	-15 to 46	-15 to 46
Operating Range Heating	°C db	-15 to 15	-15 to 15	-15 to 15	-15 to 15	-15 to 24	-15 to 24
Pipe Sizes (Liquid / Gas)	mm	6.35 / 12.70	9.52 / 15.88	9.52 / 15.88	9.52 / 15.88	9.52 / 15.88	9.52 / 15.88
Maximum Pipe Length / Lift	m	30 / 30	50 / 30	50 / 30	50 / 30	50 / 30	50 / 30
Maximum Pre-charged Length	m	20	20	30	30	30	30
Power Supply	Ph / V / Hz	1ph / 220-240V / 50Hz	1ph / 220-240V / 50Hz	1ph / 220-240V / 50Hz	1ph / 220-240V / 50Hz	1ph / 220-240V / 50Hz	3ph / 380-415V / 50Hz

## SUPER DIGITAL INVERTER [SDI] - SINGLE PHASE

INDOOR UNIT		RAV-GM561CTP-A	RAV-GM801CTP-A	RAV-GM1101CTP-A	RAV-GM1401CTP-A	RAV-GM1601CTP-A
OUTDOOR UNIT		RAV-GP561ATP-A	RAV-GP801ATP-A	RAV-GP1101ATP-A	RAV-GP1401ATP-A	RAV-GP1601ATP-A
Cooling Capacity Range	kW	5.0 [1.2 - 6.0]	7.1 [1.9 - 8.0]	10.0 [2.6 - 12.0]	12.5 [2.6 - 14.0]	14.0 [2.6 - 16.0]
Heating Capacity Range	kW	5.6 [0.9 - 7.4]	8.0 [1.5 - 11.3]	11.2 [2.4 - 13.0]	14.0 [2.4 - 18.0]	16.0 [2.4 - 19.0]
EER		3.70	4.36	4.15	3.60	3.40
COP		4.38	4.30	4.40	4.05	3.72
Maximum Operating Current	A	13.10	15.80	29.00	29.00	29.00
Dimensions - Indoor [H x W x D]	mm	235 x 950 x 690	235 x 1270 x 690	235 x 1586 x 690	235 x 1586 x 690	235 x 1586 x 690
Dimensions - Outdoor [H x W x D]	mm	630 x 800 x 300	890 x 900 x 320	1340 x 900 x 320	1340 x 900 x 320	1340 x 900 x 320
Weight - Indoor / Outdoor	kg	23 / 43	29 / 67	37 / 102	37 / 102	37 / 102
Airflow [H / M / L]	l/s	250 / 200 / 150	391 / 277 / 208	516 / 375 / 283	566 / 425 / 333	566 / 458 / 350
Sound Pressure Level Indoor / Outdoor	dB(A)	37 / 48	41 / 52	44 / 51	46 / 53	46 / 58
Operating Range Cooling	°C db	-15 to 52	-15 to 52	-15 to 52	-15 to 52	-15 to 52
Operating Range Heating	°C db	-20 to 24	-20 to 24	-20 to 24	-20 to 24	-20 to 24
Pipe Sizes (Liquid / Gas)	mm	6.35 / 12.70	9.52 / 15.88	9.52 / 15.88	9.52 / 15.88	9.52 / 15.88
Maximum Pipe Length / Lift	m	50 / 30	50 / 30	75 / 30	75 / 30	75 / 30
Maximum Pre-charged Length	m	20	30	30	30	30
Power Supply	Ph / V / Hz	1ph / 220-240V / 50Hz	1ph / 220-240V / 50Hz	1ph / 220-240V / 50Hz	1ph / 220-240V / 50Hz	1ph / 220-240V / 50Hz

## SUPER DIGITAL INVERTER [SDI] - THREE PHASE

INDOOR UNIT		RAV-GM1101CTP-A	RAV-GM1401CTP-A	RAV-GM1601CTP-A
OUTDOOR UNIT		RAV-GP1101AT8P-A	RAV-GP1401AT8P-A	RAV-GP1601AT8P-A
Cooling Capacity Range	kW	10.0 [2.6 - 12.0]	12.5 [2.6 - 14.0]	14.0 [2.6 - 16.0]
Heating Capacity Range	kW	11.2 [2.4 - 13.0]	14.0 [2.4 - 18.0]	16.0 [2.4 - 19.0]
EER		4.15	3.60	3.40
COP		4.40	4.05	3.72
Maximum Operating Current	A	16.50	16.50	16.50
Dimensions - Indoor [H x W x D]	mm	235 x 1586 x 690	235 x 1586 x 690	235 x 1586 x 690
Dimensions - Outdoor [H x W x D]	mm	1340 x 900 x 320	1340 x 900 x 320	1340 x 900 x 320
Weight - Indoor / Outdoor	kg	37 / 100	37 / 103	37 / 100
Airflow [H / M / L]	l/s	516 / 375 / 283	566 / 425 / 333	566 / 458 / 350
Sound Pressure Level Indoor / Outdoor	dB(A)	44 / 51	46 / 53	46 / 58
Operating Range Cooling	°C db	-15 to 52	-15 to 52	-15 to 52
Operating Range Heating	°C db	-20 to 24	-20 to 24	-20 to 24
Pipe Sizes (Liquid / Gas)	mm	9.52 / 15.88	9.52 / 15.88	9.52 / 15.88
Maximum Pipe Length / Lift	m	75 / 30	75 / 30	75 / 30
Maximum Pre-charged Length	m	30	30	30
Power Supply	Ph / V / Hz	3ph / 380-415V / 50Hz	3ph / 380-415V / 50Hz	3ph / 380-415V / 50Hz

Refer to the Engineering Databook for details on these conditions and requirements.

Rate conditions: Cooling: Indoor 27 °C Dry Bulb / 19 °C Wet Bulb, Outdoor 35 °C Dry Bulb.  
Heating: Indoor 20 °C Dry Bulb, Outdoor 7 °C Dry Bulb / 6 °C Wet Bulb.  
Base on equivalent piping length of 7.5m and piping height difference of 0m.

# CONTROLS AT YOUR FINGERTIPS



## WIRELESS REMOTE CONTROLLER KIT

### RBC-AXU31-E

Wireless remote controller with a standalone discreet receiver, making it easily accessible with added flexibility of placement.

#### FUNCTIONS:

- Easy to use controller
- Start / Stop
- Operational mode change
- Temperature setting
- Air flow changing
- Timer function
- Check code display

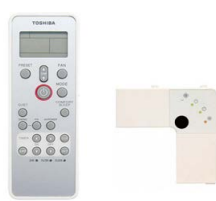

## WIRELESS CONTROLLER KIT

### RBC-AXU31UM-E

The wireless infra-red remote controller kit features an easy to use and compact button layout along with standard control buttons.

#### FUNCTIONS:

- On / Off
- Operation mode
- Temperature setting
- Fan speed
- Louvres



## COMPACT WIRED CONTROLLER

### RBC-ASCU11-E

Back to basics with this remote controller offering all the standard functionalities with compact dimensions and a large screen.

#### FUNCTIONS:

- On / Off
- Operation mode
- Temperature setting
- Fan speed
- Louvres
- Fault codes
- Unit setup



## STANDARD WIRED CONTROLLER

### RBC-AMTU31-E

The standard remote controller to control an individual indoor unit or a group of 8 indoor units.

#### FUNCTIONS:

- On / Off
- Operation mode
- Temperature setting
- Fan speed
- Louvres
- Fault codes
- Unit setup
- Button restrictions



## BACKLIT WIRED CONTROLLER

### RBC-AMSU51-ES

The ultimate in local controller with built in 7-day timer, large screen and menu.

#### FUNCTIONS:

- On / Off
- Operation mode
- Dual set point
- Fan speed
- Louvres
- Return back
- Energy savings
- Frost protection
- Soft cooling
- Leak detection
- Fault codes

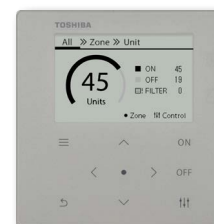

## 64 CENTRAL CONTROLLER

### TCB-SC640U-E

This standard central controller allows easy control and simple monitoring for up to 64 indoor units through its easy touch panel operation.

#### FUNCTIONS:

- Full control of up to of 64 units
- Individual indoor unit, group [up to 10 groups]
- Simple and intuitive interface with user friendly menus
- On / Off, operation mode, temperature, fan speed
- Large backlit display
- Touch-sensitive keys
- Embedded digital outputs

# ADVANCED CONTROLS

**TOSHIBA**  
**AIR CONDITIONING**



128 SMART MANAGER

**BMS-SM1281ETLE**

This Smart Manager has the ability to control from a local area network with dedicated interface accessible from every web browser.

**FUNCTIONS:**

- On / Off
- Temperature setting
- Error display
- Schedule timer
- Web connection
- Energy monitoring
- Error information transfer function by E-mail



256 TOUCH SCREEN CONTROLLER

**BMS-CT2560U-E**

This controller is ideally suited to any small or large installation where energy monitoring functions are required.

**FUNCTIONS:**

- Full control of maximum 256 units
- 7" Colour touch screen
- Intuitive navigation
- Advanced scheduling of indoor and outdoor units
- Energy monitoring with or without power meter
- Embedded input and output
- Dedicated fault code menu with email transfer capability



512 TOUCH SCREEN CONTROLLER

**BMS-CT5121E**

Ideal controller to suit commercial applications such as offices, hospitals, retirement villages, hotels etc. where energy monitoring functions are required.

**FUNCTIONS:**

- Full control of max 512 indoor units
- 12.1" Large coloured touch screen
- Quick and accurate view of indoor unit's status
- Floor, building, tenant and system overview
- Built-in web browser
- Weekly timer [up to 20 programs per day]
- Energy monitoring with graph - view operating hours, set point, inside/outside temperature and power consumption
- E-mail alert



SMART DEVICE CONTROL [WIFI]

**BMS-IWF0320E**

A versatile interface for Toshiba light commercial and VRF air conditioning units that enables WiFi connection.

**FUNCTIONS:**

- Remote access via app on a smart device
- On / Off
- Temperature setting
- Fan speed
- Timer function
- Schedule function
- Energy save function
- Permit / Prohibit function
- Error display
- Room temperature monitoring

# TOSHIBA

## AIR CONDITIONING

Toshiba is committed to continuously improving its product to ensure the highest quality and reliability standards are met, and to meet local regulations and market requirements.

The specifications on this document may change without notice to allow Toshiba to incorporate the latest products and innovations for its customers. The information contained in this brochure are merely informative, they are not intended to be used in place of the Engineering or Installation Manuals.

Cooling and heating capacities mentioned for the products are nominal capacities at standard operating conditions.

All images provided in this document are used for illustration purposes only.

Equipment rates in accordance with MEPS GEMS 2019 Determination.

AHIC [Australia] Pty Ltd, the importer and distributor of Toshiba branded air conditioning systems declines any responsibility in the broadcast sense, for damage, direct or indirect, arising from the use and interpretation of the recommendation in this document.

**AHIC [AUSTRALIA] Pty Ltd**

### ENQUIRIES

info@ahi-carrier.com.au

### SALES & SERVICE

Telephone:

13 COOL [13 26 65]

Head Office:

AHIC [Australia] Pty Ltd

Level 1 / 152 Wellington Road

Clayton, Victoria 3168

ABN:

37 606 792 456

**For more information, visit our website  
[toshiba-aircon.com.au](http://toshiba-aircon.com.au)**



*Better Air Solutions*